



# AP11LCD / AP11LED

## 10 Zone Off Board Alarm Panel

### Engineering Manual

## SAFETY

Before proceeding with the installation, please note the following safety warnings:

**DO NOT connect the mains supply directly to the products, this will cause permanent damage to the products.** Control panel is for indoor use only. Avoid mounting location which can expose this product to splashing or dripping liquid.

Always follow the manufacturer's advice when using any tools power tools, ladder/steps, using steps or ladders, and wear suitable protective equipment (e.g. safety goggles) when drilling holes, etc. The use of ear defenders are advisable when working in close proximity to the External Siren or the Control Panel's Siren when the front panel cover is removed due to the high sound level produced by it. Before drilling holes in walls, check for hidden electricity cables and water pipes. The use of a cable/pipe locator is advisable if in doubt. Batteries (battery pack or batteries installed) should not be exposed to excessive heat. Danger of damage to the unit may occur if battery is incorrectly replaced. Replace only with the same or equivalent type. (Do not mix batteries type).

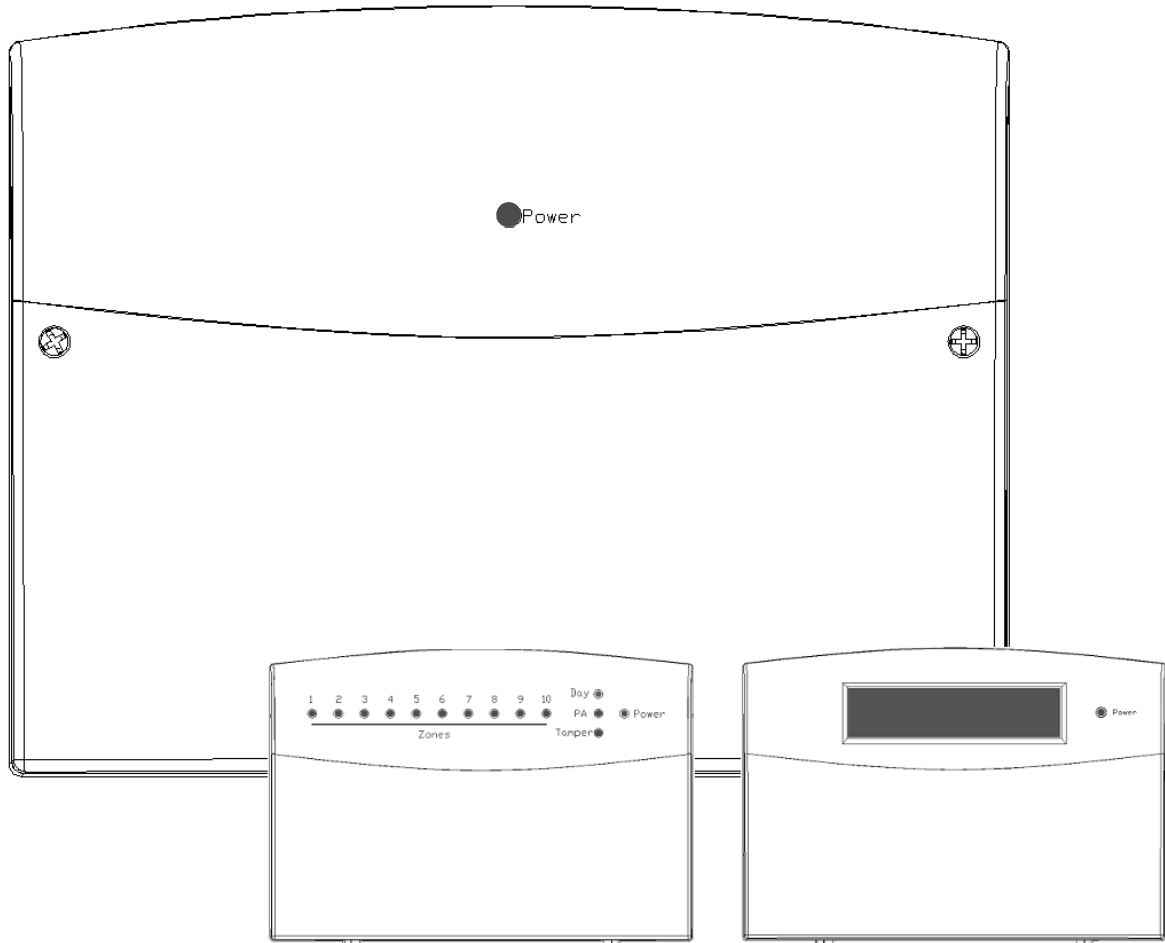

## Table of Contents

<b>SECTION 1 - OVERVIEW OF SYSTEM.....</b>	<b>4</b>
1.1 - Kit Contents.....	4
1.2 - Tools Required .....	4
1.2 - Tools Required .....	5
1.3 - System Feature .....	5
1.4 - Explanation of Terms .....	5
<b>SECTION 2 – INSTALLING YOUR SYSTEM.....</b>	<b>6</b>
2.1 - Fixing the Control Panel.....	6
2.2 - PCB .....	7
2.3 - Tamper network .....	7
2.4 - Remote Keypads.....	7
2.5 - Security Zones .....	9
2.6 - Fire Zone Circuit .....	9
2.7 - Tamper Zone Circuit .....	9
2.8 - PA Zone Circuit.....	10
2.9 - Doorbell Zone Circuit .....	10
2.10 - Keyswtich Circuit.....	10
2.11 - Exit Terminate Circuit.....	11
2.12 - Extension speaker.....	11
2.13 - External Siren Output (Bell box).....	12
2.14 - 13V Supply Output.....	12
2.15 - Set.....	12
<b>SECTION 3 - FACTORY DEFAULT SETTING .....</b>	<b>13</b>
<b>SECTION 4 - MAINS CONNECTION .....</b>	<b>14</b>
<b>SECTION 5 - FIRST POWER UP .....</b>	<b>14</b>
<b>SECTION 6 – HOW TO SET UP THE SYSTEM.....</b>	<b>16</b>
<b>6.1 - LED Keypad .....</b>	<b>16</b>
6.1.1 - Setup Programs.....	16
6.1.2 - Setup Zones Type .....	21
6.1.3 - Setup Zones Attrs .....	22
6.1.4 - Setup Codes .....	24
6.1.5 - Setup system.....	26
6.1.6 - Misc menu .....	31

6.1.7 - View Event Log.....	31
6.1.8 - Test System .....	32
<b>6.2 - LCD Keypad .....</b>	<b>35</b>
6.2.1 - Setup Programs.....	35
6.2.2 - Setup Zones Type .....	39
6.2.3 - Setup Zones Attributes .....	42
6.2.4 - Setup Codes.....	43
6.2.5 - Setup system.....	46
6.2.6 - Misc menu .....	53
6.2.7 - View Event Log.....	57
6.2.8 - Test System .....	58
<b>SECTION 7 - USING SYSTEM.....</b>	<b>61</b>
<b>7.1 – LED Keypad.....</b>	<b>61</b>
7.1.1 - Setting the System .....	61
7.1.2 - How to OMIT a zone(s) .....	62
7.1.3 - Unsetting the System.....	62
7.1.4 - How to UNSET from Alarm and RESET the system .....	63
7.1.5 - How to use Panic Alarm on keypad .....	63
<b>7.2 - LCD Keypad .....</b>	<b>64</b>
7.2.1 - Setting the System .....	64
7.2.2 - How to OMIT a zone(s) .....	64
7.2.3 - Unsetting the System.....	65
7.2.4 - How to UNSET from Alarm and RESET the system .....	65
7.2.5 - How to use Panic Alarm on keypad .....	66
<b>SECTION 8 - MAINTENANCE .....</b>	<b>67</b>
<b>SECTION 9 - TROUBLESHOOTING GUIDE .....</b>	<b>67</b>
<b>SECTION 10 - SPECIFICATIONS.....</b>	<b>69</b>
<b>APPENDIX 1 – EVENT LOG MESSAGES.....</b>	<b>71</b>
<b>APPENDIX 2 – ZONE – LOCATION &amp; PROGRAMMING TABLE ....</b>	<b>72</b>
<b>DISPOSAL AND RECYCLING.....</b>	<b>72</b>
<b>ERRORS AND OMISSIONS .....</b>	<b>73</b>
<b>MENU MAP .....</b>	<b>74</b>

## Section 1 - Overview of System

The 10 zone intruder alarm system is an indoor alarm system based on advanced technology to give professional levels of protection and reliability. It is 10 zones wired system with special electronic design for short-circuit protection. It is simple to use, to be installed by a competent installation engineer, special tools or training is required.

**IMPORTANT** – Please read this manual carefully, in full, before commencing Installation. You will find installation easier if you follow these steps in the sequence shown.

### 1.1 - Kit Contents

#### AP11LCD 10 Zone Intruder Alarm Panel with LCD Keypad

The system comprises of:

##### **10 ZONE OFF-BOARD CONTROL PANEL**

This is the heart of the system. It receives signals from detectors. Accepts input from a user and activates warning devices such as siren and strobe lights.

##### **LCD REMOTE KEYPAD**

Uses a programming system after it connects with control panel.

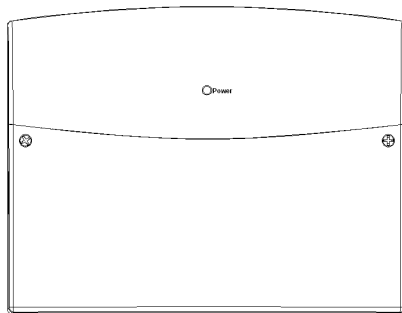

LCD Control Panel

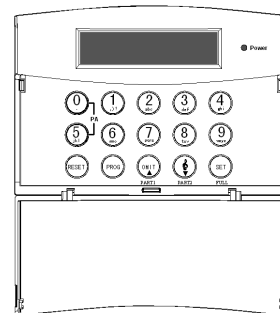

LCD Remote Keypad

#### AP11LED 10 Zone Intruder Alarm Panel with LED Keypad

The system comprises of:

##### **10 ZONE OFF-BOARD CONTROL PANEL**

This is the heart of the system. It receives signals from detectors. Accepts input from a user and activates warning devices such as siren and strobe lights.

##### **LED REMOTE KEYPAD**

Uses a programming system after it connects with control panel.

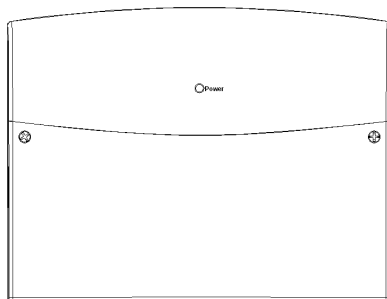

LCD Control Panel

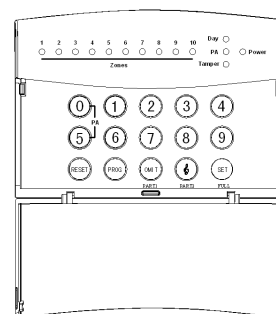

LED Remote Keypad

## 1.2 - Tools Required

- Large and small flat bladed screwdrivers
- Large and small cross-point screwdrivers
- Power drill
- Hammer & ear defenders
- 5mm, 8mm and 10mm masonry drill bits
- Sharp knife
- Wire cutters & wire stripper
- Ladder or other safe working platform
- Cable Detector

## 1.3 - System Feature

- 10 Zones programmable for security, PA, Fire, 24Hr Tamper.
- TAMPER input
- Output for External Siren and Strobe.
- 4 Access Level Codes, manager code, engineer code, user code (LED system has two, LCD system has ten ), holiday code, all programmable.
- 1 Full set and 2 fully selectable part set programs.
- Chime on any security zone
- 250 events memory for LCD Keypad, 16 events memory for LED Keypad
- Programmable timers for exit, entry and bell cut off
- Walk Test mode
- Quick set system
- Single Key Set mode
- Name zone for LCD remote keypad
- Supports up to four remote keypads with on board PA , Keys positioned up to 100 meters from control panel.
- Keypads can be wired in a star or daisy chain configuration from control panel
- Non-volatile memory for protection of engineer program, manager and event log.
- Battery capacity of up to 2.1AH

## 1.4 - Explanation of Terms

**Zone** – A logical area that is monitored by one detector.

**Disarm** – It is the normal state of the system when the house is occupied. Enter your four-digit user PIN code would return to OFF state.

**Full Alarm (ARM state)** – The CU will sound full alarm (internal siren) when it receives alarm signals.

**Part Arm (Home state)** – Arming the system so that certain zones omitted (i.e. will not trigger an alarm).

**Entry/Exit Zone** – Zone that allows timed entry/exit in to/out the premises before alarm activation

**OK Beep** – Rapid double tone; it indicates correct operation.

**Error Beep** – Long single tone; it indicates incorrect operation.

## Section 2 – Installing your System

In choosing a suitable location you should bear in mind:

- The need to reach the keypad easily, within the 30 seconds, when entering and leaving the premises, ideally passing only one detector.
- The CU should not be visible from the exterior of the protected premises.
- Reception of radio signals can be affected by the presence of metal objects within a few feet of the CU. (E.g. mirrors, central heating radiators, garage doors and cars parked in garages on the opposite side of the wall. Avoid any location which is near (within 60cm) to these or any other large metal objects.

### 2.1 - Fixing the Control Panel

**CAUTION:** When positioning the control panel ensure that it is located in a dry place away from damp areas.

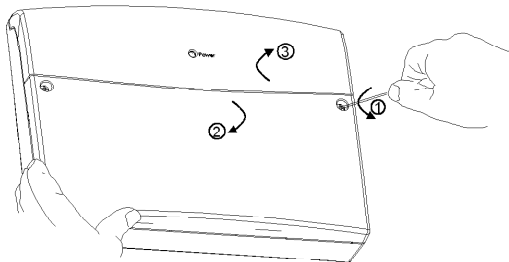

Step 1. Remove the front cover(s) from the base assembly.

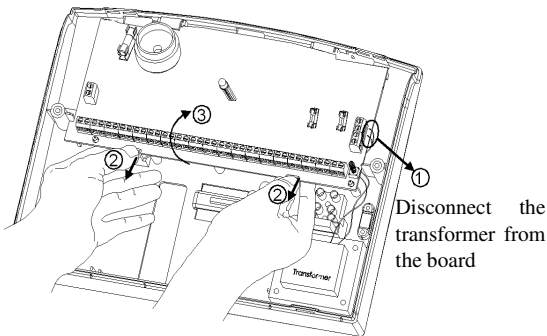

Disconnect the transformer wires from the board, these are marked AC. Carefully remove the board by gently pushing down the holding clips on the bottom edge of the board and with draw it from the base.

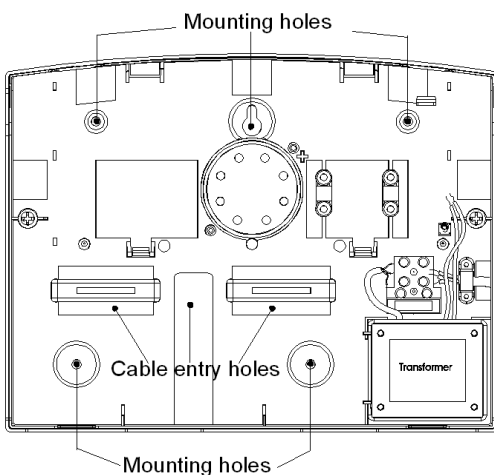

Step 2. Fit the panel to wall with suitable fixings. Ensure the wall surface is flat to prevent base distortion. There are cable entry holes provided in the rear of the base and around the outside edges through the thinned out plastic sections which may be cut away as required.

Step 3. The hole provided adjacent to the mains transformer is a dedicated mains cable entry point.

## 2.2 - PCB

There are three fuses mounted on the circuit board. All are 20mm anti-surge

- F1 1.6A – to protect the positive (+Ve) line of 12V battery
- F2 1A – to protect the RKP 13V supply
- F3 1A – to protect the Siren (Bell)&Strobe supply

As supplied, wire links are fitted across the Tamper terminal to represent a closed circuit.

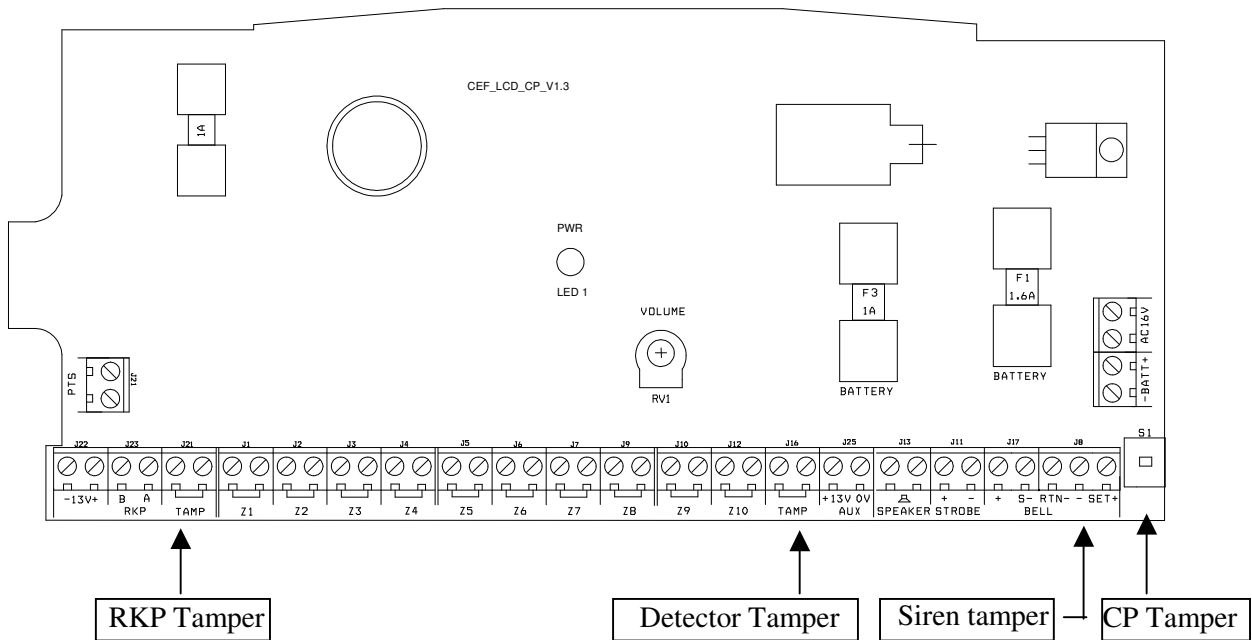

**CAUTION:** Always power-down the panel when wiring external circuits, to prevent damage to the panel electronics.

Systematically wire and test each circuit:

- Zone, Tamper circuit and PA circuits
- Finish by wiring any additional extension speaker sounders, external siren(bell)/strobe and the 13V supply.

## 2.3 - Tamper network

The Tamper circuit is used to protect all cables and detectors in the system from unauthorized access including the panel and RKP covers.

The zone and PA tampers should be series wired and connected to TAMP terminals.

Terminals RTN-&- are for the external siren tamper. The TAMP terminals at the bottom left of the board are for the RKP tampers.

## 2.4 - Remote Keypads

**CAUTION:** When the LCD Control Panel is being installed ensure there is at least one LCD /LED remote keypad wired to the panel before first power up.

A combination of up to four LCD/LED remote keypads can be connected to the panel.

**LCD /LED remote keypad connects with LCD control panel**

**1). Select remote keypad jumper**

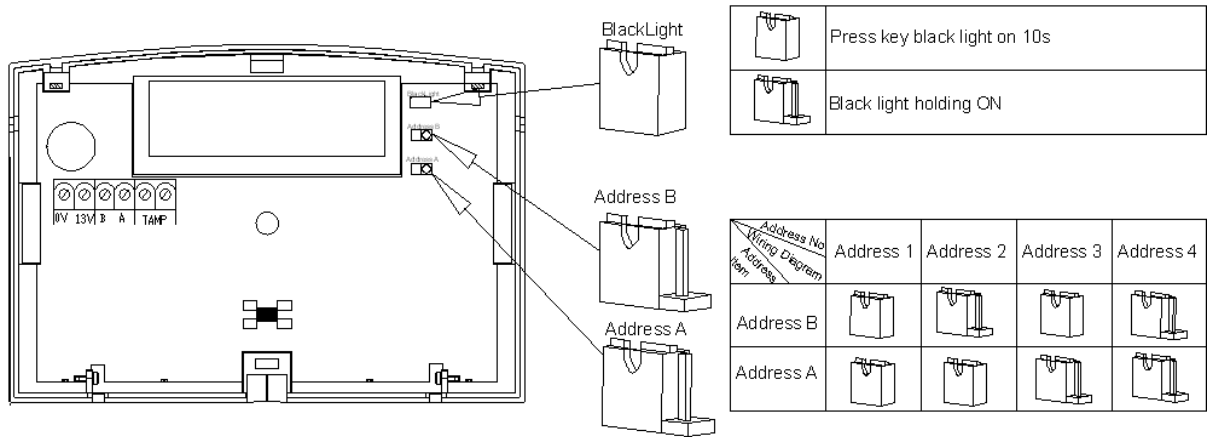

**2). Wiring diagram**

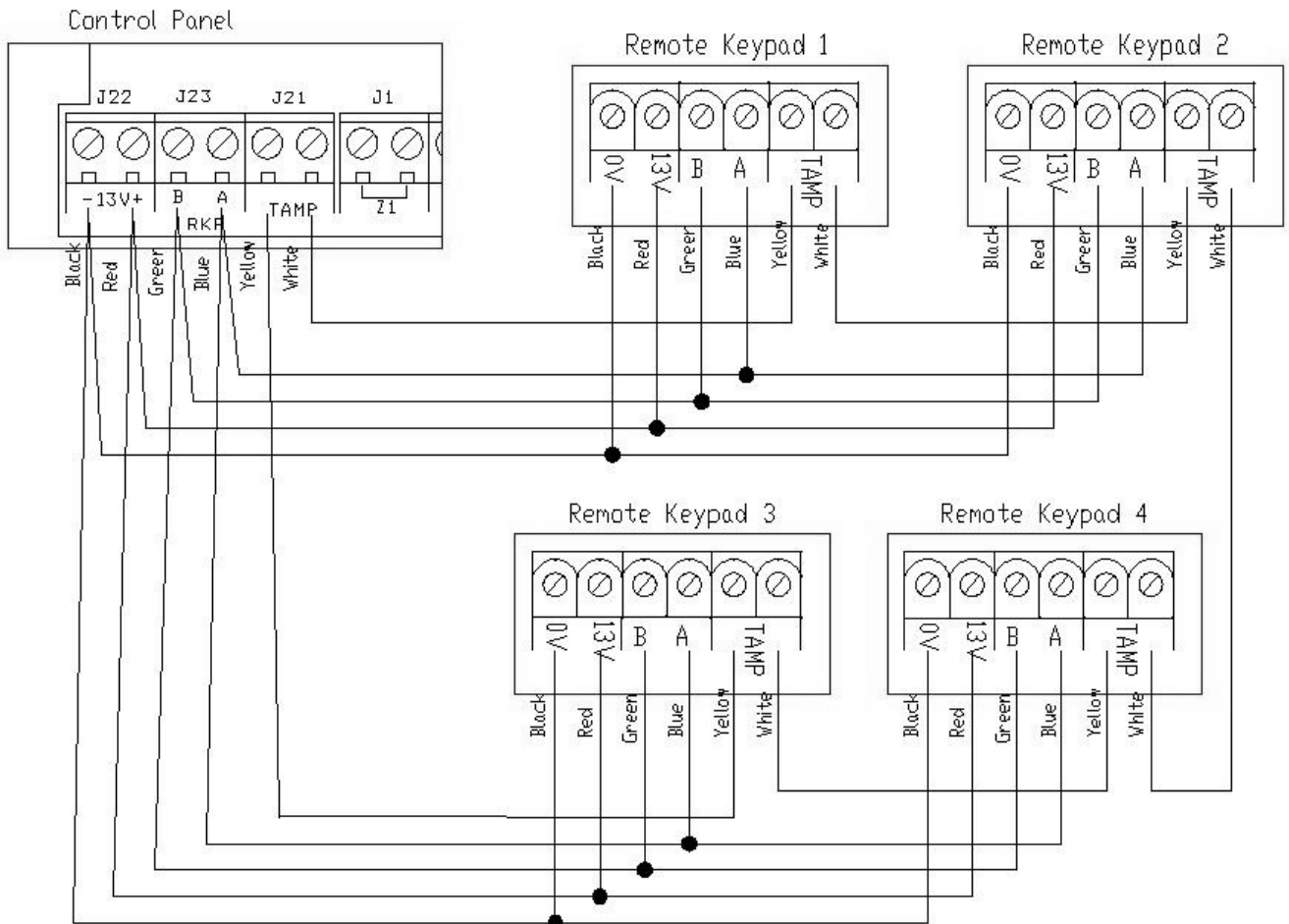

- Separate the RKP base plate from the main assembly by slackening the retaining screw.
- Cut away the required thin wall sections around the edges of the base plate for cable entry.
- The base plate may be fitted directly to the wall using the screws and wall plugs supplied, if these are not appropriate for the wall the use suitable alternative fixings.
- Bring the cables into the base plate and wire to the terminal block on the base plate, see diagram on the previous page.



- e. Refit the RKP main assembly to the base plate by hooking it onto the top holding clips. Check that the wiring is not trapped by the tamper switch/spring or the PCB support pillar. Inset the screw and tighten in the bottom of the case.

## 2.5 - Security Zones

PIR and door contact connect to control panel block diagram, only one device per alarm zone.

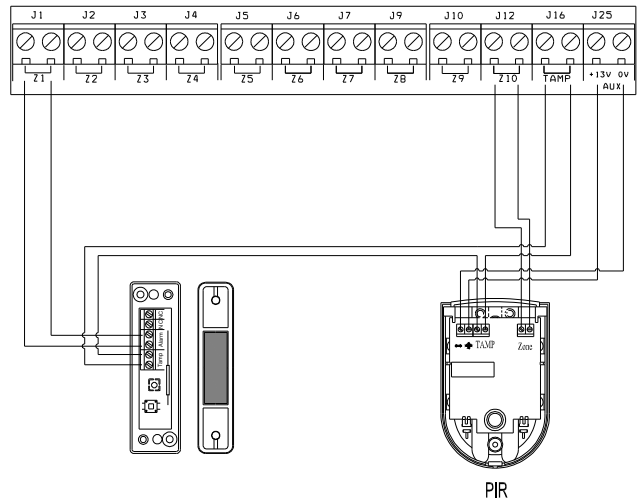

## 2.6 - Fire Zone Circuit

Any zone may be programmed as a fire zone. This will automatically exclude the availability of the zone from programs and normal security applications. (Normally closed circuit required)

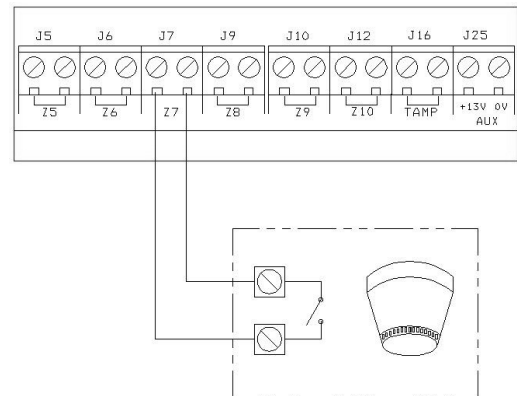

## 2.7 - Tamper Zone Circuit

Any zone may be programmed as a Tamper zone. Operational in Day and set, the Tamper circuit will cause a full alarm condition when activated. (Normally closed circuit required)

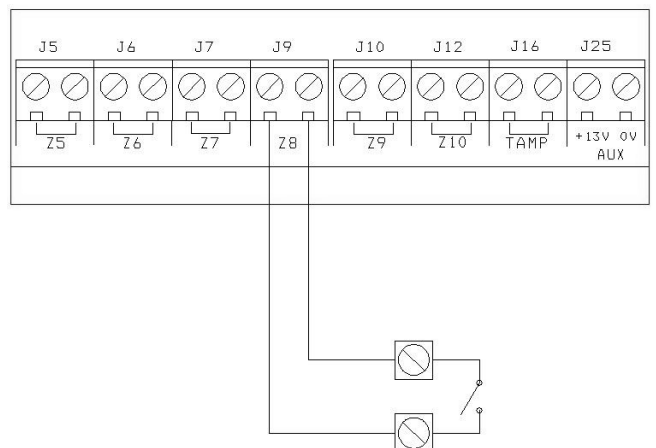

## 2.8 - PA Zone Circuit

Any quantity of normally closed type personal attack button may be wired in series and then connected to the PA circuit.

If a zone is required for PA this will require programming, refer to section 6.2.2.2

Operational in Day and set, the PA circuit will cause a full alarm condition when activated. PA is indicated on the control panel or RKP as Attack.

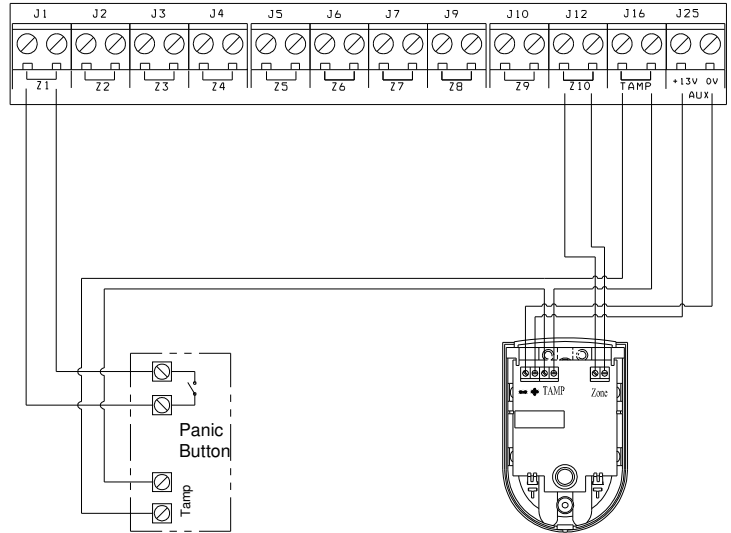

## 2.9 - Doorbell Zone Circuit

Any zone may be programmed as a Doorbell zone. Operational in Day and set, the Doorbell circuit will cause Doorbell sound.

(Normally closed circuit required)

The PTS terminals on the PCB can also be used as doorbell. A normally open contact such as doorbell push could used.

(ensure flag 2 is set to door Bell)

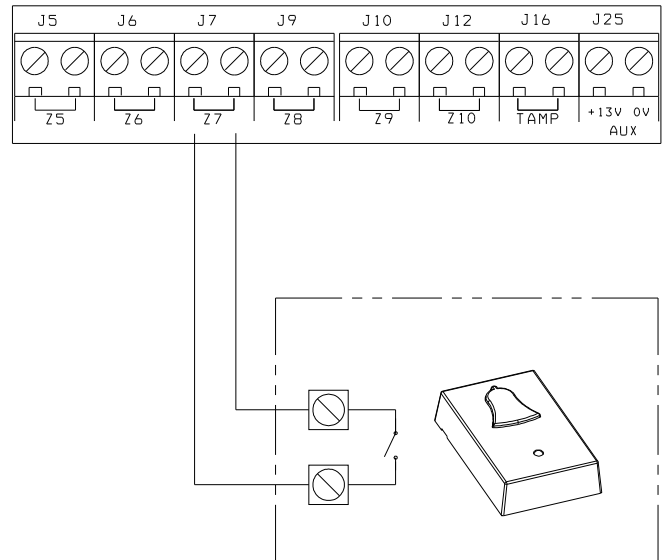

## 2.10 - Keyswitch Circuit

When Keyswitch flag is set ON, system to be SET and UNSET with the use of a key switch in PTS terminal.

(Normally open unset, normally closed set)

### Note

The PTS cannot be set to as a doorbell and keyswitch

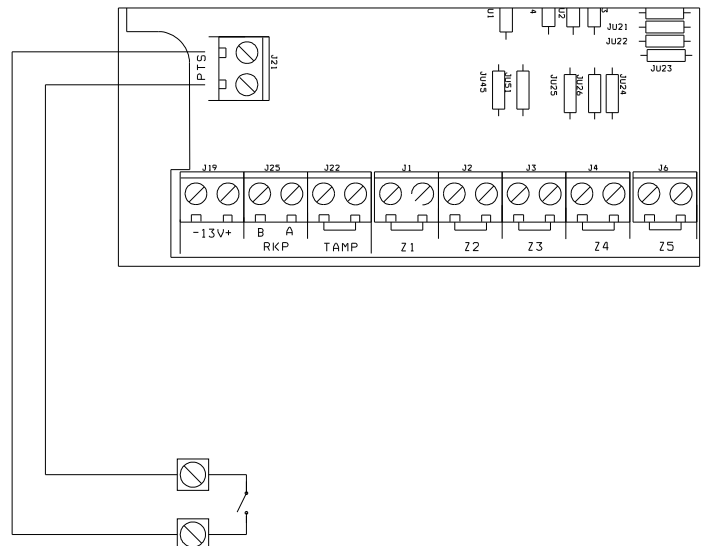

## 2.11 - Exit Terminate Circuit

If the Exit Terminate is programmed in the Exit mode the exit time will not time out until a momentary normally open switch has triggered the PTS terminals. Pressing the button once on PTS will terminate the exit time and the system will set immediately.

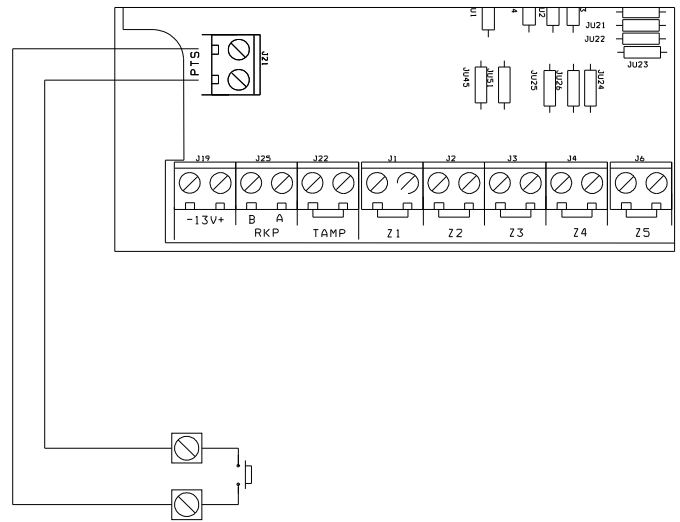

## 2.12 - Extension speaker

Extension speaker may be connected to the loudspeaker terminals to produce high volume alarm tones and low volume entry/exit/fault tones.

*External speaker connects to control panel*

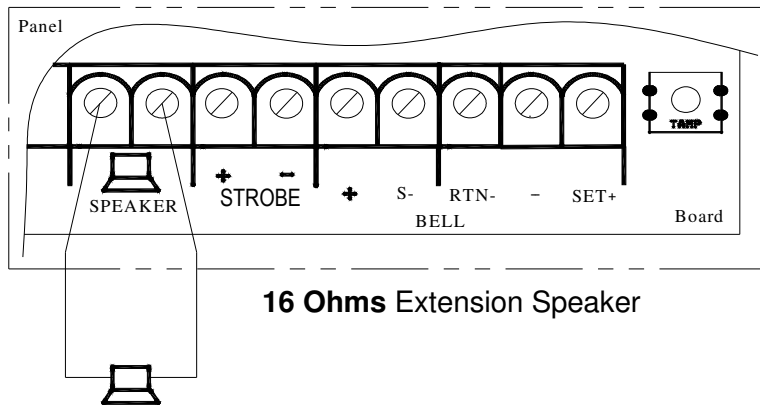

Only one 16 ohm extension speaker may be wired across the speaker terminals. Mounted in convenient position within the installation the extension speaker will reproduce all of the alarm tones generated by the control panel.

A control marked VOLUME in the center of the board may be used to adjust the low volume entry/exit tones to suit environmental conditions.

The factory fitted sounder inside the control panel is not a speaker and the volume cannot be adjusted.

## 2.13 - External Siren Output (Bell box)

The external siren (bell box) is usually installed in a high position from where the siren could be seen and heard.

Terminal + S- RTN- - strobe + and - are for connection to the external siren. These terminals provide a power/hold –off supply, sounder trigger and tamper circuit to protect the external siren housing.

The terminals are summarized as follows:

- + +Ve supply (13V)
- S- -Ve Sounder trigger
- RTN- -Ve tamper return
- -Ve supply (0)
- Strobe + -

Where a discrete external siren is used, it should be connected to terminals + & S-. Terminals RTN- & - are then used for tamper protection for the housing.

### *Bell box wiring to control panel*

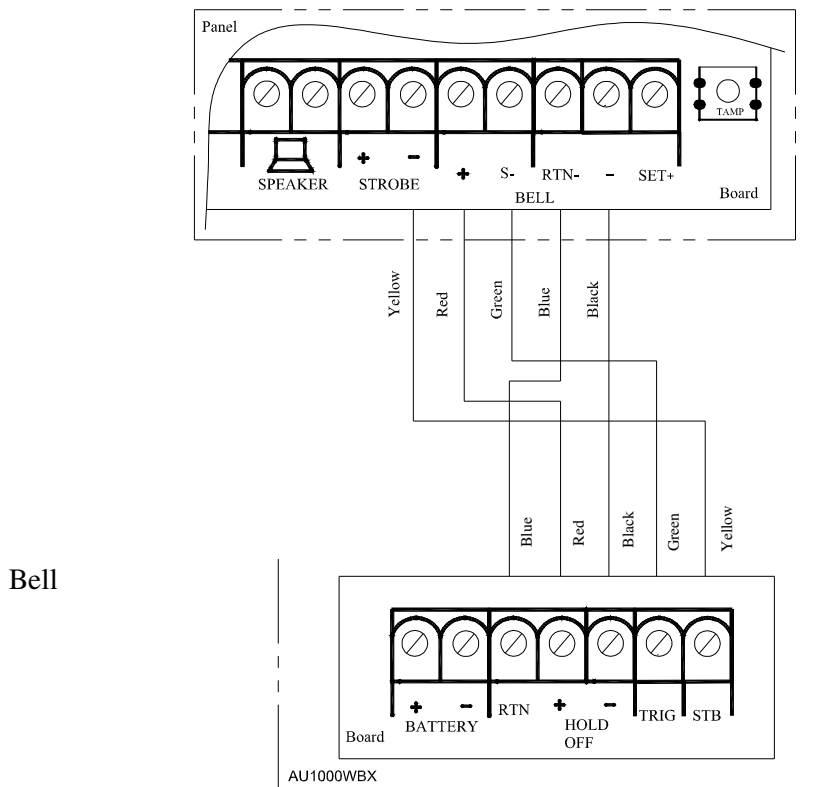

## 2.14 - 13V Supply Output

The 13V output is to power detectors which require a voltage supply (PIR detector etc). The supply is present at all times and may be used to supply a total of 350mA.

## 2.15 - Set

The output marked SET becomes positive on correct Set of the system and is removed by entry of a valid user code.

## Section 3 - Factory Default Setting

### System status

User code 1-10 : Not used  
 Holiday code : Not used  
 Manager code : 0123  
 Engineer code : 9999  
  
 Bell time : 14 minutes  
 Bell delay time : No delay  
 Rearm Count : 3 Rearms  
 Service Date : 01/01/09  
 System Time : 00:00:00  
 System Date : 08-08-08  
 Alarm INFO text is Null  
  
 Zone type : Security  
 Omit Allowed : Off  
 Double Knock : Off  
 Chime : Off







### System flag

Silent PA : Off  
 RKP PA : On  
 Engineer Reset : Off  
 PA user Reset : On  
 Fire user Reset : On  
 Bell in Fire : On  
 Disable Bell Tamper : Off  
 Lock Engineer Code : Off  
 Auto walk test exit : Off  
  
 Key Switch : Off  
 PTS as Doorbell : Off  
 Strobe on SET : On  
 Single key SET : Off  
 EOLR zone : Off  
 EN compliant : Off  
 Daylight Saving : Off  
 Service Timer : Off

### SET mode

**Full mode:**  
 Zone 1 : Timed  
 Zone 2 : Inhibited  
 Zone 3-10 : Immediate  
 Exit Mode : Timed Exit  
 Exit Time : 45 sec  
 Entry Time : 45 sec  
  
**Part 1 mode:**  
 Zone 1,2 : Timed  
 Zone3-8 : Immediate  
 Zone 9-10 : Not Used  
 Exit Mode : Timed Exit  
 Exit Time : 45 sec  
 Entry Time : 45 sec  
  
**Part 2 mode : Disabled**

### Indications on the system

Indications	
LED steady on indication	
LED flashing indication	
LED off	
Internal Sound	
External Device: Strobe	
External Siren: Bell	

### Defaulting Manager code and Engineer code

1. Power down panel.
2. Remove wiring from SET+ output and TAMP input.
3. Fit shorting wire between SET+ and right-hand TAMP terminal.
4. Power up.
5. Wait for alarm to start.
6. Power down panel and then restore original wiring.

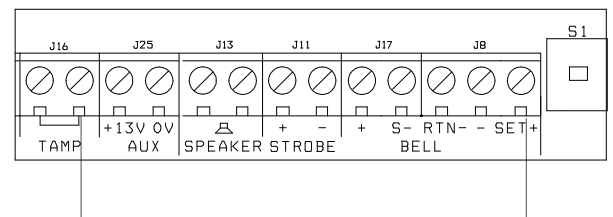

## Section 4 - Mains Connection

The mains power should be connected using a 3 core cable of not less than 1mm sq. from a fused spur to the mains connector inside the control panel.

**NOTE:** The mains supply must be connected by a technically competent person and according to current IEE regulations.

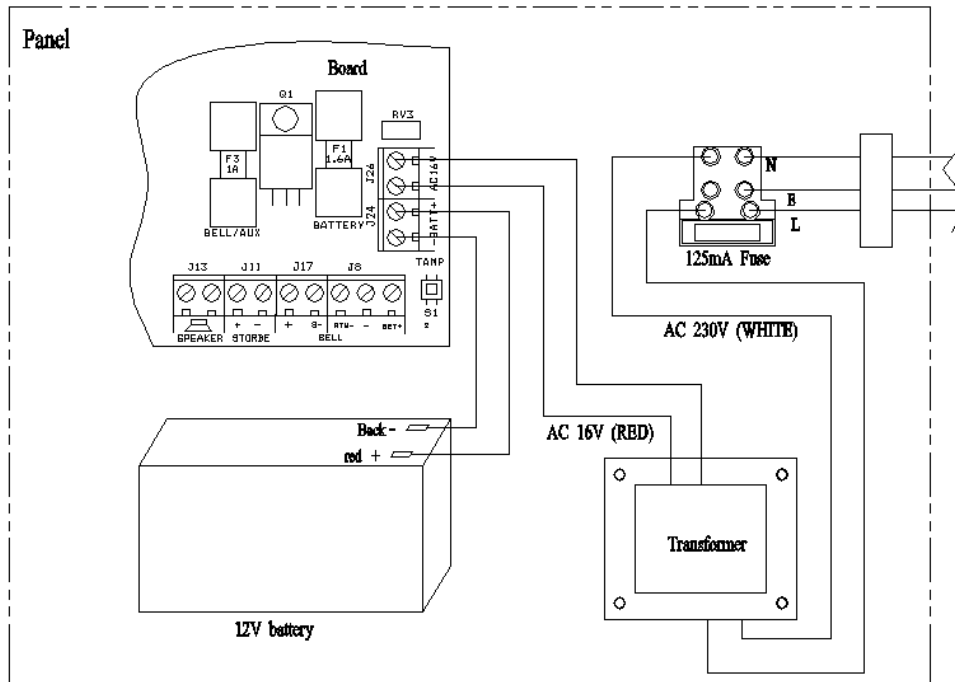

**CAUTION:** To avoid the risk of electrical shock you must always totally isolate the mains supply before opening the control panel cover(s).

Mains input fuse rating: 125mA, 250V type.

On connecting the mains supply to the panel the power indicator is lit. \* Power

### Testing the System

Complete the wiring of the system and then:

- Fully test the system and ensure it is fault free.
- Fully program the system.
- Fill in the installation log at the back of the manual and retain it for future reference.
- Finally explain the operation of the system to the end user.

## Section 5 - First Power Up

Before power up, for AP11LED panel only – fit the top cover on to the base and connect the speaker wires. Leave the cover in position throughout the reset of the installation.

- a. Check that the factory fitted links are connected to terminals TAMP and RTN-& -.
- b. Fit the battery wires to the BATT terminals on the Board, Red to + and Black to -.

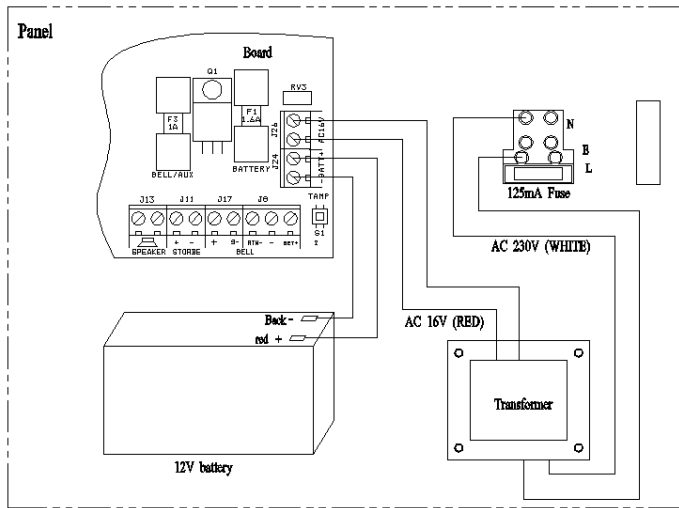

c. On connecting the battery the system will now go into alarm condition and Day led is will be lit.

**LCD INDICATIONS**

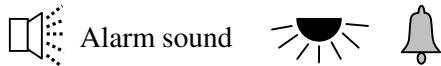
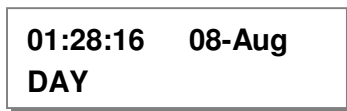

**LED INDICATIONS**

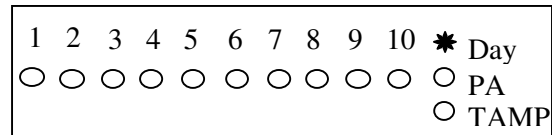

d. Fit the cover to hold down the tamper spring at the bottom right-hand of the board.

e. Enter User code / Manager code 0 1 2 3 (factory set code).

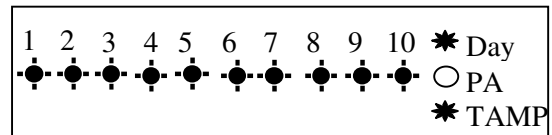

f. Press RESET to return to Day mode.

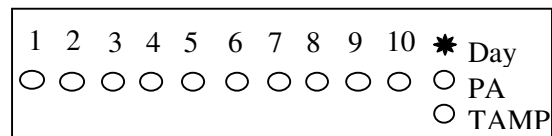
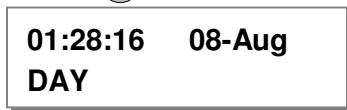

g. Immediately enter the engineer code 9-9-9-9 factory default setting

h. The system will go into Engineer program mode.

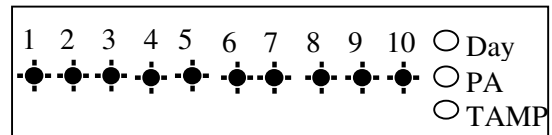

**Engineer Program Mode**

The control panel may be programmed to suit a wide variety of installations.

Once the engineer program mode has been accessed, each configuration may be changed in any order.

Before entering engineer program mode the system should be in the Day mode, with the Day and Power indicators lit.

## Section 6 – How to Set up the system

### 6.1 - LED Keypad

#### How to enter Engineer Program Mode

You should require the manager to authorize Engineer access. It is accessed directly from Day mode via the Manager code.

To operate the “**Engineer Authorise Access**” as follow:

##### LED Remote Keypad:

- Enter Manager program mode.
- Press **PROG 0 1 2 3** (Default)
- Press **3** to authorize Engineer access. Then Engineer can access program mode within 3hr hour.
- Press to **RESET RESET** leave the current menu.
- Input 4-digit Engineer code **9 9 9 9** and go to engineer operation window within 5 seconds.

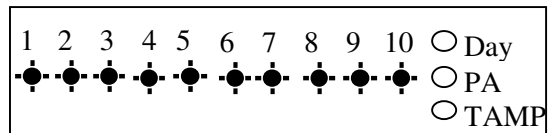
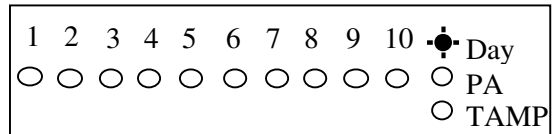
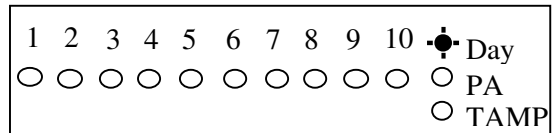
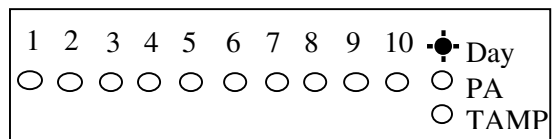

#### 6.1.1 - Setup Programs

The panel has three programs: **1 = Program Full, 2 = Program Part1, 3 = Program Part2.**

Each program can set all parameters independent, these are **1 = Zone Function, 2 = Exit Mode, 3 = Exit Time, 4 = Entry Time.**

Zones can also be assigned different functions in different programs. Refer to the following diagram for the programming structure.

##### 6.1.1.1 - How to go into Full mode Setting

##### LED Remote Keypad:

- Under Engineer mode.
- Press **1** to Select **Setup Programs.**
- Press **SET** to accept and go into **Program Full.**

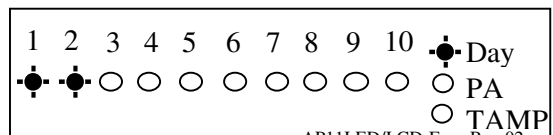
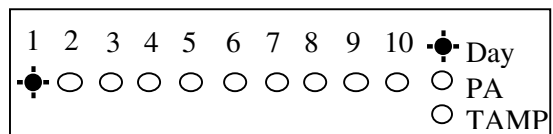



**6.1.1.2 - How to go into Part 1 mode Setting**

**LED Remote Keypad:**

- Under Engineer mode.
- Press **1** to Select **Setup Programs**.

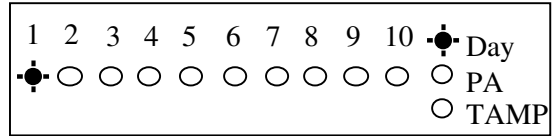

- Press **OMIT** to accept and go into **Program Part 1**.

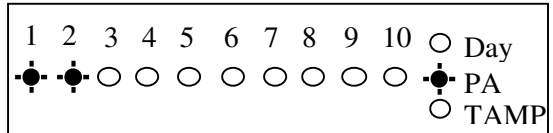

**6.1.1.3 - How to go into Part 2 mode Setting**

**LED Remote Keypad:**

- Under Engineer mode.
- Press **1** to Select **Setup Programs**.

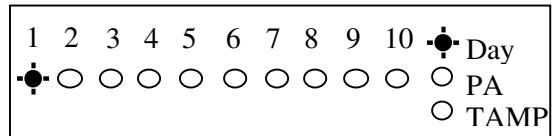

- Press **&** to accept and go into **Program Part 2**.

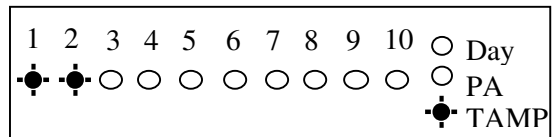

**6.1.1.4 - How to set zone function**

In **Zone Function**, Security type zones can be assigned different functions. These are **1= Immediate (alarm) Zone, 2 = Timed (entry/exit) Zone, 3 = Inhibited (walkthrough) Zone.**

**Immediate (Alarm) Zone:**

Use this function when the zone is not part of an entry/exit route. When the system is **SET**, activation of an immediate zone will cause a full alarm condition.

**Timed (Entry/Exit) Zone:**

A time zone would be used to protect an entry/exit route. Opening the door or triggering the sensor in this type of zone when the system is **SET** will start the entry timer.

**Inhibited (Walkthrough) Zone:**

A time-inhibited zone operates as an immediate zone unless a timed zone has been operated and a timer started. Such a zone should be utilized to allow passage between the entry/exit door and the control panel when there are detectors present.

**LED Remote Keypad:**

**Set zone Immediate function**

Under Engineer Menu/Setup Program, the program Full mode is chosen. LED 1 and LED 2 is flashing.

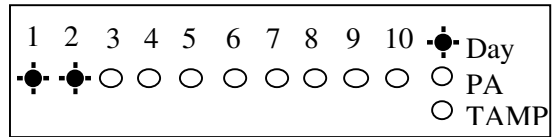

- Press **1** to program Immediate (Alarm) Zone. LED 1~10 ON indicate selected immediate zones.  
Default settings are LED's 3~10 on.

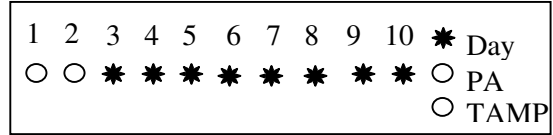

- To edit the other zones press Zone number (1~10). If select, LED is on.  
If select Zone 2 to be immediate zone,

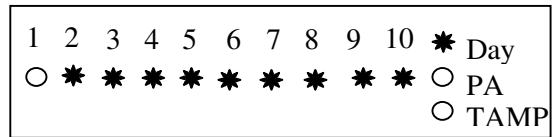

- Press **SET** to accept the change  
Or press **RESET** to cancel.

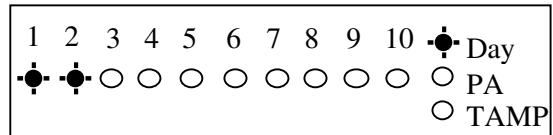

**Set zone Timed (Entry/Exit) function**

Under Engineer Menu/Setup Program, the program Full mode is chosen. LED 1 and LED 2 is flashing.

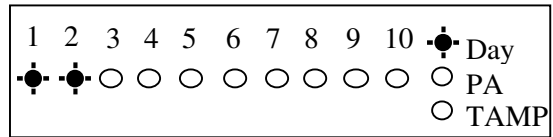

- Press **2** to program Timed Zone. LED 1~10 ON indicate selected Timed zones.  
Default settings are LED 1 on.

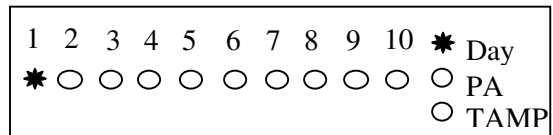

- To edit the other zones press Zone number (1~10). If select, LED is on.  
If select Zone 4 to be immediate zone,

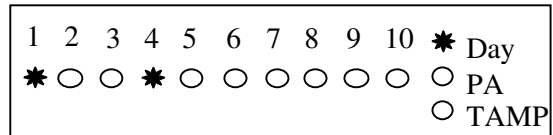

- Press **SET** to accept the change  
Or press **RESET** to cancel.

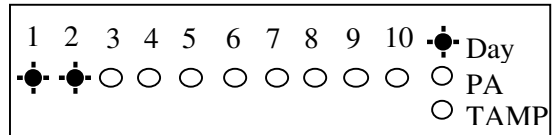

**Set zone Inhibited (Walkthrough) function**

Under Engineer Menu/Setup Program, the program Full mode is chosen LED 1 and LED 2 is flashing.

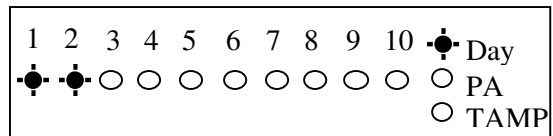

- Press **3** to program Timed Zone. LED 1~10 ON indicate selected Timed zones.  
Default settings are LED 2 on.

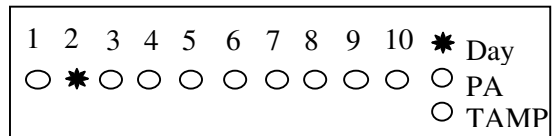

- To edit the other zones press Zone number (1~10). If select, LED is on.  
If select Zone 3 to be inhibited zone,  
Then press **2** , and press **3**

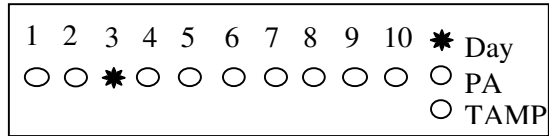

- Press **SET** to accept the change  
Or press **RESET** to cancel.

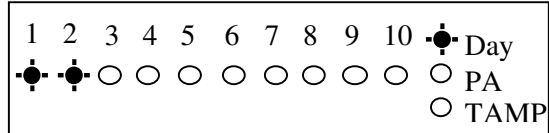

**6.1.1.5 - How to set Exit mode function**

There are four selections for **Exit Mode** in all mode: **1 = Timed Exit, 2 = Final Door, 3 = Silent Exit, 4 = Terminated, 0 = Disable.**

**Timed Exit:**

A timed program will set once the exit timer has expired and all zones are clear.

**Final Door:**

A final door program will set 5 seconds after the final door has been opened and closed.

**Silent Exit:**

This operates exactly the same as **Timed Exit** but completely silent without internal sounder signal.

**Terminated:**

A terminated program will set once the PTS terminal has been trigger.

**Disable:**

A disabled program is not available for use and cannot be selected and setting time.

**LED Remote Keypad:**

Under Engineer Menu/Setup Program, the program Full mode is chosen. LED 1 and LED 2 is flashing.

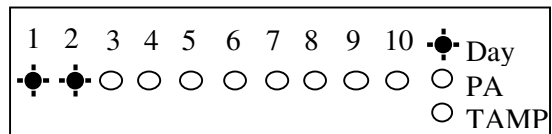

- Press **4** to program Exit Mode.  
LED 1 ON indicates system selected: Timed

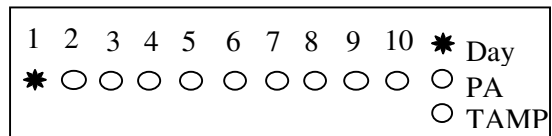

- Change exit mode to Silent.  
Press **3** to select silent

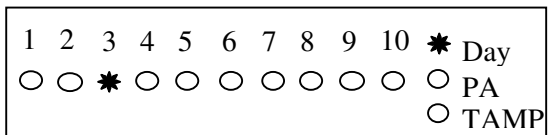

- Press **SET** to accept the change  
Or press **RESET** to cancel.

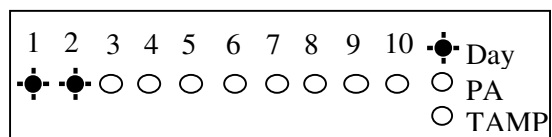

**6.1.1.6 - How to set Exit time function**

This is the time allowed to leave the premises via the exit route before the system sets. The programmable range is 00-99 seconds.

If the **Exit Time** is interrupted within the last 10 seconds, then the **Exit Time** will restart at 10 seconds after the interruption has cleared.

The default is 45 seconds.

**LED Remote Keypad:**

Under Engineer Menu/Setup Program, the program Full mode is chosen. LED 1 and LED 2 is flashing.

- Press **5** to select Exit time item.  
Z1, Z2 LED light indicate you input 2 digit Number.
- Set the exit time of full set mode 20 seconds.  
Then Press **2** digit number, Z1 LED off .
- Then Press **0** digit number, Z2 LED off .  
PA and TAMP LED flashing indicate for you to accept or cancel.
- Press **SET** to accept the change.  
Or press **RESET** to cancel.

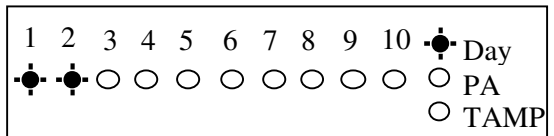
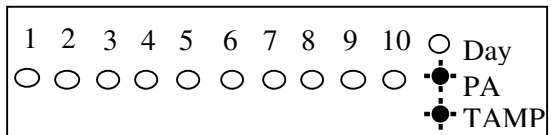
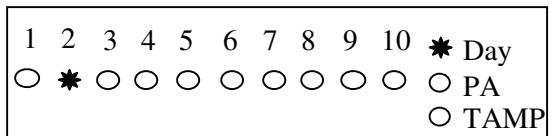
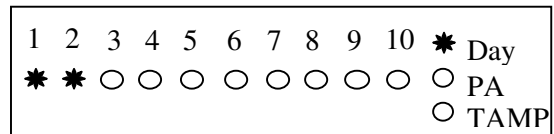
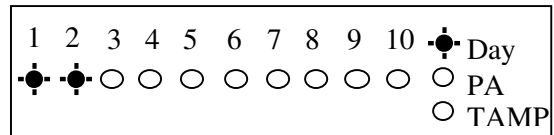

**6.1.1.7 - How to set Entry time function**

This is the time allowed to enter the premises via the entry route and unset the system. The programmable range is 00-99 seconds. The default is 45 seconds.

**LED Remote Keypad:**

Under Engineer Menu/Setup Program, the program Full mode is chosen. LED 1 and LED 2 is flashing.

- Press **6** to select Entry time item.  
Z1, Z2 LED light indicate you input 2 digit Number.
- Set the exit time of full set mode 20 seconds.  
Then Press **2** digit number, Z1 LED off .
- Then Press **0** digit number, Z2 LED off .  
PA and TAMP LED flashing indicate for you to accept or cancel.

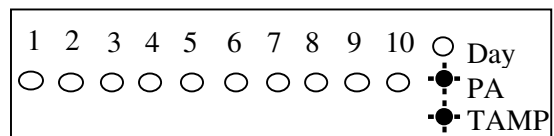
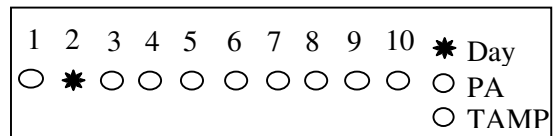
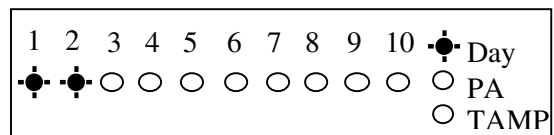

- Press **SET** to accept the change. Or press **RESET** to cancel. Press **RESET** to return to Engineer mode.

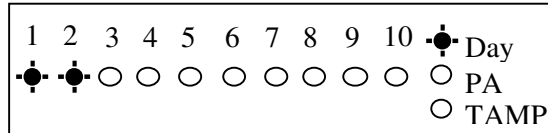

## 6.1.2 - Setup Zones Type

The 'Setup Zones Type' contains: 1 = Zone name, 2 = Zone type.

### 6.1.2.1 - How to set Zone Name

#### LED Remote Keypad:

The LED Remote Keypad cannot program zone names.

### 6.1.2.2 - How to set Zone Type

There are six types for Zone: **1 = Security, 2 = PA, 3 = Door Bell, 4 = Fire, 5 = Tamper/24H, 0 = Not Used.**

#### **Security:**

The system comes supplied with factory links fitted to the zone terminals to simulate a closed circuit. As each zone is connected these links should be removed. All zones are fully programmable. When the panel is set a security zone creates an immediate alarm.

#### **PA:**

A Zone may be programmed for audible PA and should be wired in series. This is 24hr and operates if panel is set or unset.

#### **Door Bell:**

This feature can be programmed into any Zone. A doorbell will not operate whilst the entry/exit timers have started, when the system is in full alarm condition or whilst in programming mode.

#### **Fire:**

If you choose to utilize a zone as a fire zone then no other detectors may be wired into this zone. Therefore a zone cannot be both fire and intruder. This is zone 24hr operates when panel is set or unset.

#### **Tamper/24H:**

Provides 24 hour monitoring.

#### **Not used**

A zone may be programmed for Not used, then is ignored by the panel.

To operate the Setup Zone type as follow.

e.g. Change zone 5 type to Fire zone.

**LED Remote Keypad:**

- Under Engineer mode.
- Press **2** to select set up Zone Type.

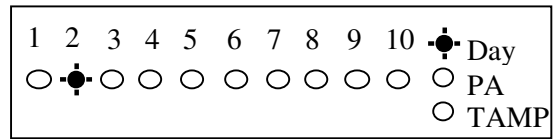

- Press a number button to select Zone to be Configured ie. Press **5** to select zone 5, Zone 5 is Security.

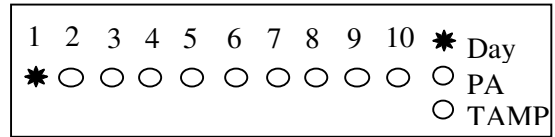

- Press **4** to select Fire

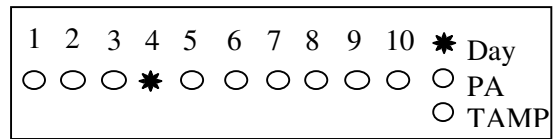

- Press **SET** to accept the change. or press **RESET** to cancel. Press **RESET** to return to engineer mode.

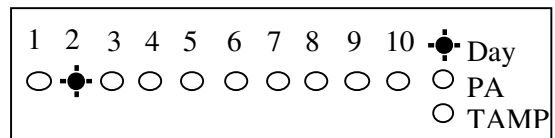

**6.1.3 - Setup Zones Attrs**

There are three attributes for Zone: 1 = Omit Allowed, 2 = Double Knock, 3 = Chime. You can set it ON or OFF.

**Omit Allowed:**

When a Zone is programmed as Omit Allowed, the panel allows the Zone to be Omitted for one set period by the user when setting the system.

**Note: The zone type must be set to Security for the “Omit Allowed” function.**

**Double Knock:**

Double knock programming is used when zones are likely to create false activations.

Double knock requires two activations within 10 minutes of the same Zone or a Zone left open for 10 seconds.

**Chime:**

If a Security Zone is programmed as Chime, then chime tone is activated when it is triggered in DAY mode.

**Note: Only zones programmed for security can chime.**

To operate the Setup Zone attribute as follow.

e.g. Set zone 2 have Omit Allowed, Double Knock and Chime attributes (set ON).

**LED Remote Keypad:**

***Omit Allowed***

- Under Engineer mode
- Press (3) to select Zone Attributes menu.

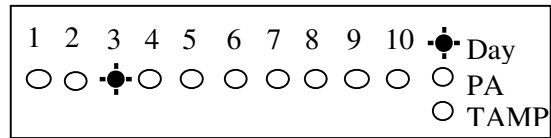

- Press zone No. to select zone (0~9).  
If you set Zone 1 attribute is omit allowed.

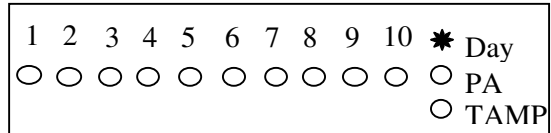

- Press (1) to select Omit Allowed.

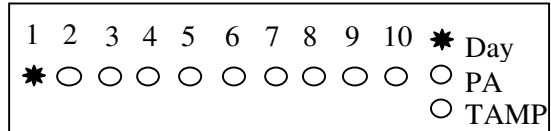

- Press (SET) to accept the change  
Or press (RESET) to cancel.

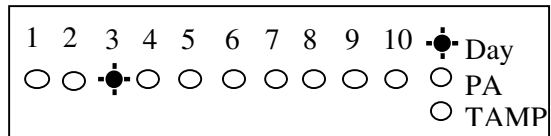

***Double Knock***

- Under Engineer mode.
- Press (3) to select Zone Attributes menu.
- Press zone No. to select zone (0~9)  
If you set Zone 4 attribute is double knock.

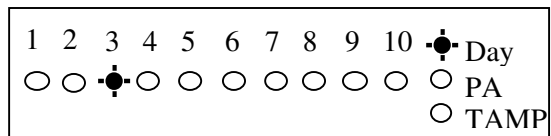

- Press (2) to select double knock.

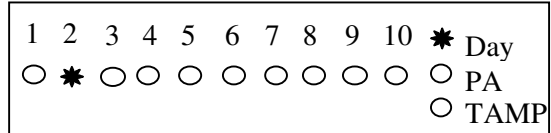

- Press (SET) to accept the change  
or press (RESET) to cancel.

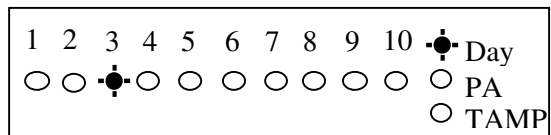

***Chime***

- Under Engineer mode
- Press (3) to select Zone Attributes menu.

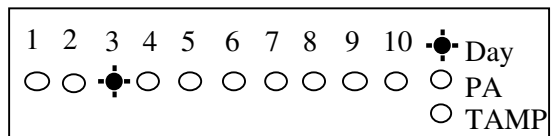

- Press zone No. to select zone (0~9).  
If you set Zone 5 attribute is Chime.

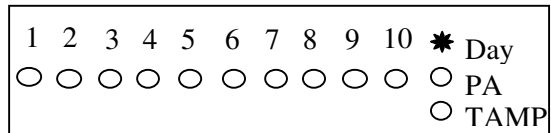

- Press (3) to select Chime.

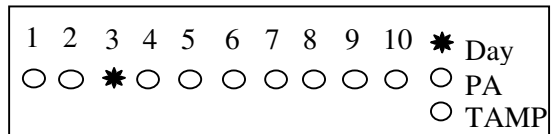

- Press (SET) to accept the change. Or press (RESET) to cancel. Press (RESET) to return to engineer mode.

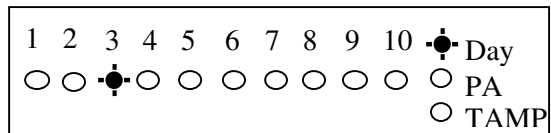

## 6.1.4 - Setup Codes

### 6.1.4.1 - How to set up User Code

There are 2 user codes can be set by LED Keypad in the system. All are 4-digit and can be set to any number from 0000 to 9999. The access codes ensure that only authorized users can operate the system.

1 = user 1, 2 = user 2, 3 = Holiday, 6=Manager's Code, 4 = Engineer

#### **Managers Code:**

The **Managers Code (default 0123)** can change all codes and has full access to the option in the user programming mode.

**Note:** The Managers Code can only be changed from the **User Programming Menu** not from engineer mode.

#### **User 1 – User 2 codes:**

The user 1 –user 2 codes have the same operation for testing and Setting and Unsetting, changing their own code.

#### **Holiday code:**

The purpose of this code is to allow access to the property whilst the manager is absent. The Holiday access code is programmed by the Manager and is only valid until the manager use's the system. At this point the Holiday code becomes invalid and is no longer accepted by the control panel.

#### **Engineer code:**

Accesses the Engineer program mode to allow the system to be programmed. If configured the Engineer's code can be used to reset the system after an alarm.

**NOTE: Entering an invalid user code 4 times will operate the code tamper and lock you out. After another 5 times invalid user code, a full alarm condition will be generated.**

### 6.1.4.2 - How to change User Name

#### **LED Remote Keypad:**

The LED Remote Keypad cannot program user names.



### 6.1.4.3 - How to change User Code

This option allows each of the users to be given a code.

#### LED Remote Keypad:

Under Engineer Menu.

- Press **4** to select Setup User codes.

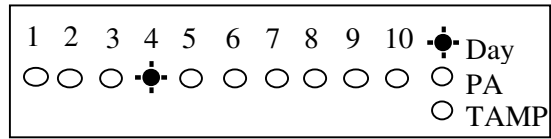

- Press **1** to change User 1.

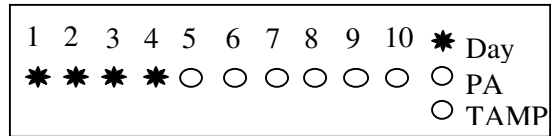

- Enter the new user 1 code (4 digits)  
**? ? ? ?** New code

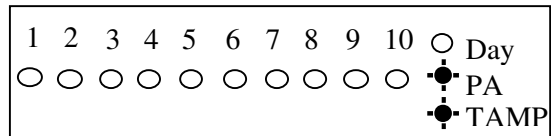

- Press **SET** key to save. If the 4-digit is the same as old, the error tone will be generated.
- Press **RESET** key will cancel and return.

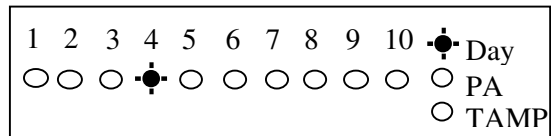

### 6.1.4.4 - How to delete User Code

#### LED Remote Keypad:

Under Engineer Menu.

- Press **4** to select Setup User codes.

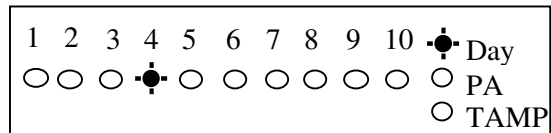

- Press **1** to change User 1.

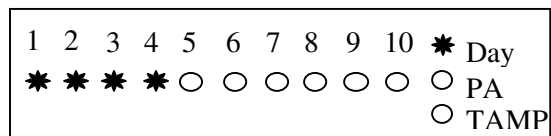

- Press **OMT** key to delete user 1 code.

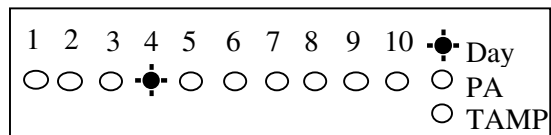

- Press **SET** to accept the change.

- Press **RESET** to return to engineer mode.

## 6.1.5 - Setup system

The catalog of Setup system contains eight parts. They are list as follow:

**1 = Flags1, 2 = Flags2, 3 = Bell Time, 4 = Rearm count, 5 = Bell delay time, 6 = Set Time, 7 = Set Date, 8 = Service Date.**

### 6.1.5.1 - How to Setup System Flags

The System Flags are divided into Flags1, 2.

#### Flag1 – Options

There are eight options under Flag1 which are described below:

2=RKP-PA, 3=Engineer Reset, 4=PA user Reset, 5=Fire user Reset, 6=Bell in Fire, 7=Disable Bell Tamper, 8=lock Engineer Code, 9=Exit Walk Test

#### RKP-PA

When this flag is set to ON, the keypad's PA function is enabled. Pressing 0 & 5 together creates a PA alarm.

#### Engineer Reset

When this flag is set to ON, an engineer code must be entered to reset the system after Tamper, PA or Fire alarm. When the flag is set to OFF the system can be reset by the user.

#### PA user Reset

When this flag is set to ON, it permits the user to reset the system after a PA alarm, by pressing user code. The user can reset the system even if the **Engineer Reset** flag is set to ON.

#### Fire user Reset

When this flag is set to ON, it permits user to reset the system after a Fire alarm by pressing user code. The user can reset the system even if the **Engineer Reset** flag is set to ON.

#### Bell in Fire

When this flag is set to ON, the external siren Bell box will sound On/two second off during the fire alarm.

#### Disable Bell Tamper

When this flag is set to ON, when the Bell Tamper is trigger in FULL, Part1, Part2 mode the alarm system will not process it.

#### Lock Engineer Code

When this flag is set to ON, the system can't reset the engineer code to default when you use "Reset NVM" command.

#### Exit Walk Test

When this flag is set to ON, it will automatically return to next option after 20 minutes.

**LED Remote Keypad:**

- Under Engineer mode
- Press (5) to select Setup system.

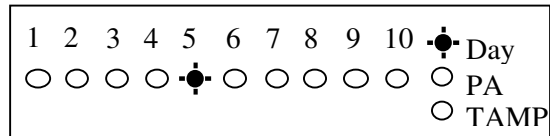

- Press (1) to select system flag item.

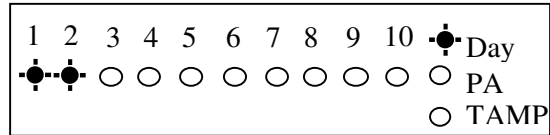

- Press (1) to select system flag 1 option. Default settings are on.

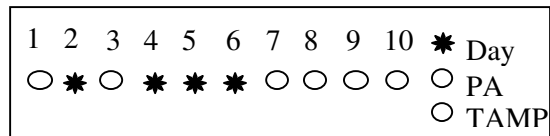

- For example, add Engineer Reset and Walk Test Auto-exit enable. Press (3) and (9) to select.

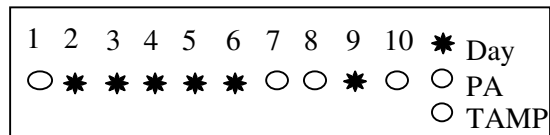

- And cancel PA User Reset, Press (4) to disable, the corresponding LED OFF.

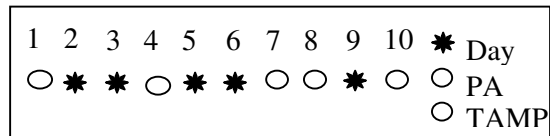

- Press (SET) to accept the change. Or press (RESET) to cancel. Press (RESET) (RESET) to return to engineer mode.

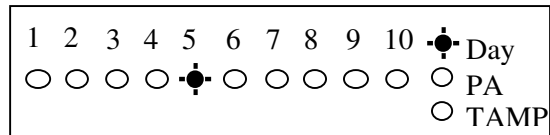

**Flag2 – Options**

There are eight options under Flag2 which are described below:

1=Key switch, 2=Doorbell, 3=Strobe on Set, 4=Single key Set, 5=EN Compliant, 6=EOLR Zone  
7=Daylight Saving, 8=Service Timer

**PTS terminals used with a Keyswitch**

When this flag is set to ON, this enables the system to be SET and UNSET with the use of a key switch in the PTS terminals (NO contacts = Day mode, NC contacts = Full Set). If the panel needs to be reset then a manager/user code must be entered.

**PTS as Doorbell**

When this flag is set to ON, Keyswitch = OFF, the PTS terminal is programmed to a doorbell (Momentary NO contacts required i.e. bell push button), if the Keyswitch = ON, the PTS terminal is used as Keyswitch.

**Strobe on Set**

When this flag is set to ON, the external strobe will stay on for five seconds once the panel has set.

**Single key Set**

When this flag is set to ON, it allows the panel to be set Full mode by pressing the [Set] button, set Part 1 mode by pressing [▲] key, set Part 2 mode by pressing [▼] key. A code entry is not required. However, a 4-digit code is required to Unset the panel.

**EN Compliant**

When this flag is set to ON, the alarm system has Battery Monitoring function.

**EOLR Zone**

When this flag is set to ON, the alarm system goes to EOLR mode. Each detector must have a 2k2 resistor connected across its alarm contacts. In addition, a 2k2 resistor must be connected across the end of the Zone wiring, as shown in the following diagram. Note the PIR detectors usually have a “spare” terminal for this purpose.

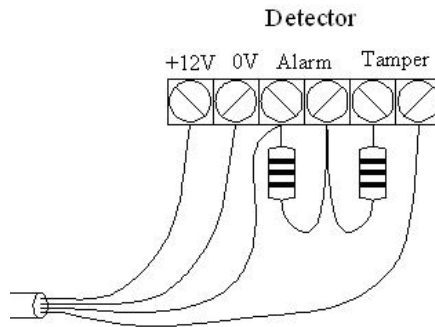

Wiring a single detector

**Daylight Saving**

When this flag is set to ON, the system will turn clock back 1 hour 2 am on the first Sunday in Apr and ahead 1 hour 2 am on the first Sunday in Oct.

**Service Timer**

When this flag is set to ON, the user can use the alarm system during Service Time.

**LED Remote Keypad:**

- Under Engineer mode.
- Press (5) to select Setup system.
- Press (1) to select system flag item.
- Press (2) to select system flag 2 option. Default settings are on.
- For example, add EN Compliant flag. Press (5) to select.
- Press (SET) to accept the change, Or press (RESET) to cancel. Press (RESET) (RESET) to return to engineer mode.

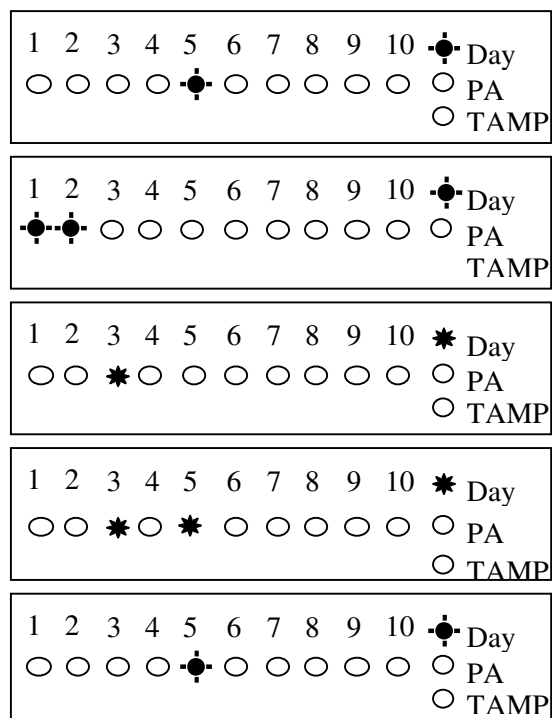

### 6.1.5.2 - How to Setup Bell Time

This is the duration that the external bell output is active. The range is 01-20 minutes. The default is 14 minutes.

e.g. Change the **Bell Time** from 14 to 15 minutes.

#### LED Remote Keypad:

- Under Engineer mode
- Press **5** to select Setup system.
  
- Press **2** to select bell time item.
  
- Press **1** and **5** to change 15 minutes.
  
- Press **SET** to accept the change.  
Or press **RESET** to cancel.

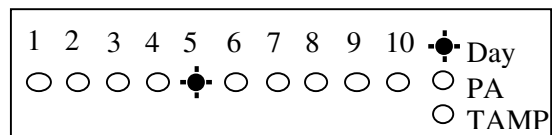
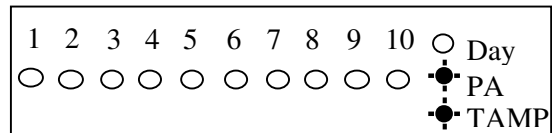
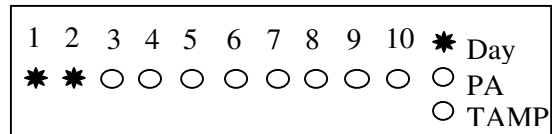
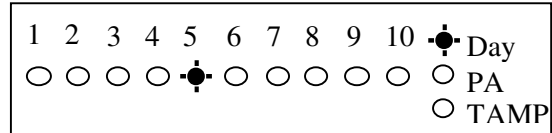

### 6.1.5.3 - How to Setup Rearm count

After an alarm the panel will automatically rearm itself when the external siren (Bell) timer has expired. Any Zones and tamper, panic which still remain open at that time will be automatically omitted.

The default is 3 rearms. 0 = no rearms, 1-8= number of rearms, 9= always rearm

e.g. Change the **Rearm Count** from 3 to Always rearm.

#### LED Remote Keypad:

- Under Engineer mode
- Press **5** to select system item.
  
- Press **3** to select rearm count item.  
LED 1 ON indicate you enter only 1 digit.
  
- Press **9** to change to always rearm.
  
- Press **SET** to accept the change.  
Or press **RESET** to cancel.

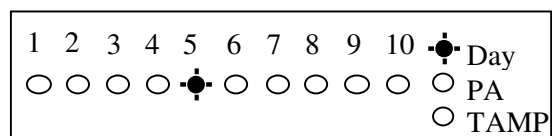
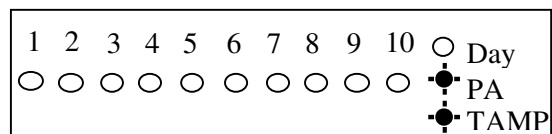
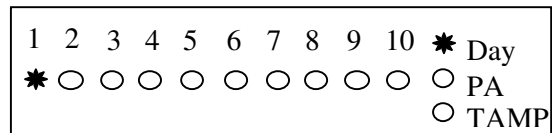
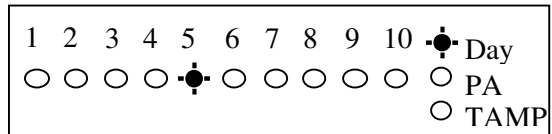

### 6.1.5.4 - How to Setup Bell delay time

This delays the activation of the Bell for the required time. The range is 00-99 minutes. The default is 00 minutes.

e.g. Change the Bell Delay time from 0 to 1 minute.

**LED Remote Keypad:**

- Under Engineer mode
- Press **5** to select system item.

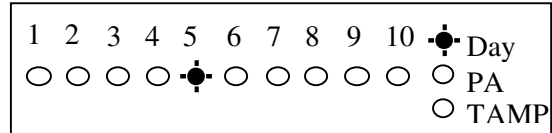

- Press **4** to select bell delay time item.  
LED 1 and 2 ON indicates you enter only 2 digits.

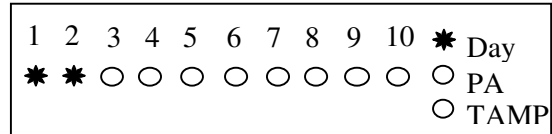

- Press **0 1** to change bell delay time.

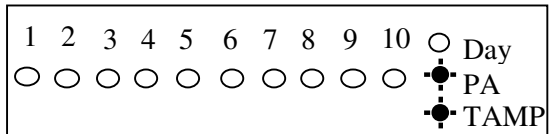

- Press **SET** to accept the change Or press **RESET** to cancel. Press **RESET** to return to engineer

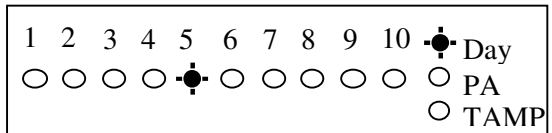

### 6.1.5.5 - How to Setup Set Time

**LED Remote Keypad:**

The LED Remote Keypad cannot set time.

### 6.1.5.6 - How to Setup Set Date

**LED Remote Keypad:**

The LED Remote Keypad cannot set date.

### 6.1.5.7 - How to Setup Service Date

**LED Remote Keypad:**

The LED Remote Keypad cannot set service date.

## 6.1.6 - Misc menu

### 6.1.6.1- How to Restore to factory default settings using the menu

Factory defaulting the system will default all factory parameters.

**CAUTION:** All configurations of the panel are reset to reset to factory default conditions.

To default to factory settings:

#### Led Remote Keypad:

- Under Engineer mode.  
LED 1~10 is flashing.

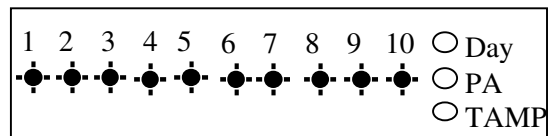

- Press **OMI** twice within 2 second when entering engineering mode.  
Rapid bleeps. All system setting returns to factory default.

**NOTE:** if Lock Engineer flag is ON, Engineer Code cannot reset to factory default

## 6.1.7 - View Event Log

The event log gives a display of all the events that have taken place. The events are arranged by date and time. Up to 16 events can be stored in the memory. When the log reaches 16 events and another event takes place, the first event drops out. The system is known as FILO (First In Last Out).

To view the event log:

#### Led Remote Keypad:

- Press:
- ① Jump to oldest event
  - ② Move one event older
  - ③ Move one event newer
  - ④ Jump to newest event
  - ⑨ Clear all alarm event

After selecting Alarm Log the zone, PA and Tamper LED's will show the latest event

A flashing LED indicates the zone that was first activated.

Any other LED lit was activated after the first event but before system unset.

- Under Engineer code

- Press  to select view alarm event.  
LED 1 flashing indicate Zone 1 is triggered first.  
TAMPER is triggered after Zone 1

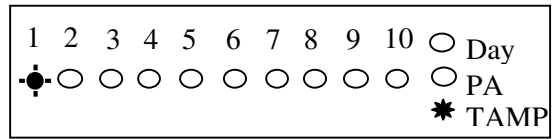

- Press  to leave view alarm log menu.

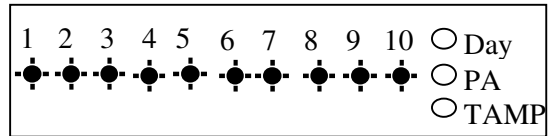

**How to clear all alarm events?**

- Under Engineer code

- Press  to select view alarm event.

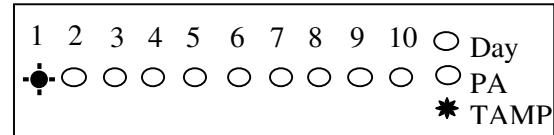

- Press  to clear all alarm events.  
System all LEDs would be dark and emit a confirm sound to indicate clear all alarm event.

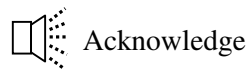
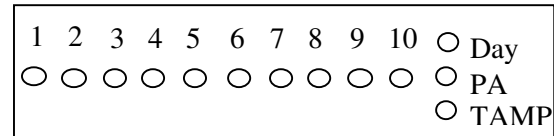

- Press  to leave view alarm log menu.

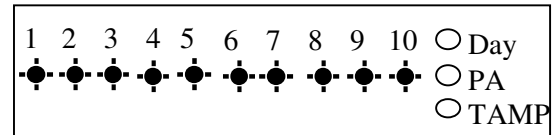

**6.1.8 - Test System**

This function has three parts in Test System:

**Test output**

**Walk Test**

**View Walk Test**



**6.1.8.1 - How to Test Outputs**

The test outputs are: **0 = BELL, 1 = Strobe, 2 = Speaker,**

**LED Remote Keypad**

- Under Engineer code
- Press **8** key to Select Test System.

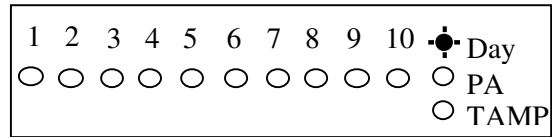

- Press **0** key to select Bell test.

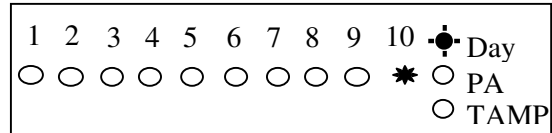

- Press **1** key to select Strobe test.

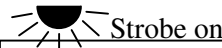
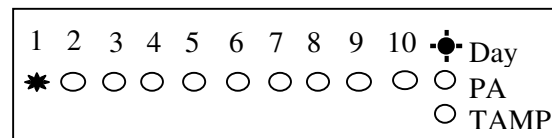

- Press **2** key to select Speaker test.

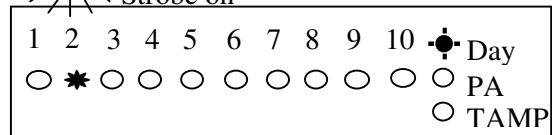

- Press **RESET** key to exit current level.

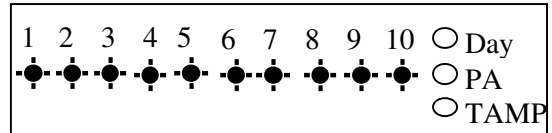

**6.1.8.2 - How to enter Walk Test**

The walk test function allows check each Zone trigger, Zone tamper, Detect Tamper, Control panel tamper, Bell Box tamper, Remote Keypad tamper. if order to verify that they are functioning correctly. A tone is generated as each zone or tamper is activated (opened).

e.g. Trigger Zone and Zone tamper

**LED Remote Keypad :**

- Under Engineer code
- Press **8** key to Select Test System.

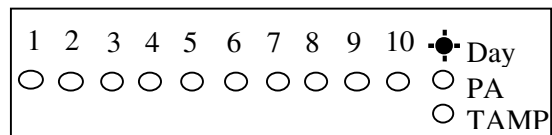

- Press **8** key to select Walk test.
- Trigger zone 1, when a zone is successfully tested, the LED is on, Zones are added to list as each one is activated.

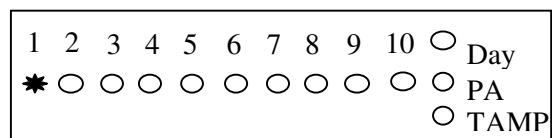

- Trigger zone 1 tamper and its appropriate led will light.

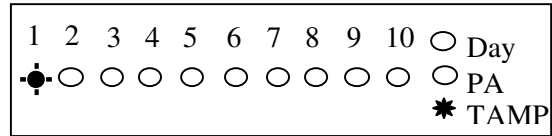

- The Tamper LED comes on when tested.

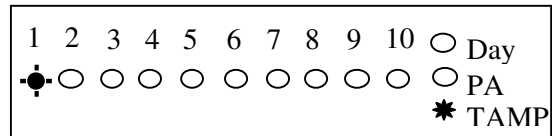

- Press  key to exit current level.

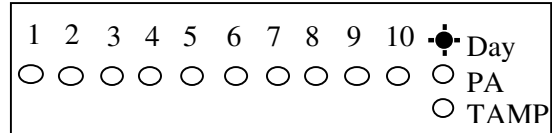

### 6.1.8.3 - How to enter View Walk Test

#### LED Remote Keypad :

The LED Remote Keypad cannot operate the menu item.

### 6.1.8.4 - How to enter View Panel Version

#### LED Remote Keypad :

The LED Remote Keypad cannot operate the menu item.

### 6.1.8.5 - How to Exit Engineer Program Menu

#### LED Remote Keypad :

- Under Engineer menu.
- Press  key return to top of engineer menu.

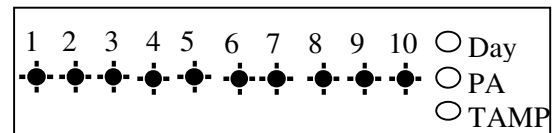

- Press  key to exit engineer program mode. and check system faults (all Tamper, TA zone, PA zone, Fire zone is open)

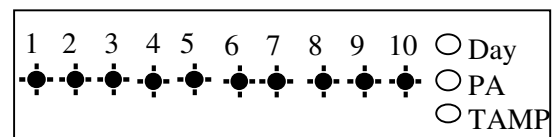

- When no fault, press any key to exit.

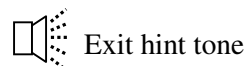

- Return to DAY mode.

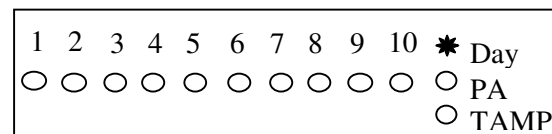

## 6.2 - LCD Keypad

The full menu structure for the panel can only be accessed while in Engineer Program Mode. The structure is shown in the following table:

MENU OPTIONS	
1 Setup Programs	5 Setup System
2 Setup Zone Names and Types	6 Misc Menu
3 Setup Zone Attributes	7 View alarm log
4 Setup Codes	8 Test System

### 6.2.1 - Setup Programs

#### How to enter Engineer Program Mode

You require the manager to authorize Engineer access. It is accessed directly from Day mode via the Engineer code.

To operate the “Enter Engineer operation mode” as follow:

##### LCD Remote Keypad:

- Enter Manager program mode  
Press **PROG** **0** **1** **2** **3**
- Press **3** key for the Manage to authorize Engineer access.
- Press **PROG** to accept. It will give a 3hr window to use the Engineer operation mode.
- Press **PROG** to accept, the accept tone will be generated.
- Press **RESET** to go back DAY mode.
- Input 4-digit Engineer code **9** **9** **9** **9** and go to Engineer operation window within 5 seconds.

**MANAGER MENU  
Setup Codes?**

**MANAGER MENU  
Authorise Engr?**

**Engr Authorised  
for 3 hours**

**MANAGER MENU  
Set Chime Zones?**

**00:26:15 08-Aug  
DAY**

**LC ENGINEER MENU  
Setup Programs?**

### 6.2.1.1 - How to go into Full mode Setting

#### LCD Remote Keypad:

- Under Engineer mode.
- Press **1** **PRCG** to Select **Setup Programs**.
- Press **1** **PRCG** to accept and go into **Program Full**.

LC ENGINEER MENU  
Setup Programs?

SELECT PROGRAM  
Program Full?

### 6.2.1.2 - How to go into Part 1 mode Setting

#### LCD Remote Keypad:

- Under Engineer mode.
- Press **1** **PRCG** to Select **Setup Programs**.
- Press **2** **PRCG** to accept and go into **Program Part 1**.

LC ENGINEER MENU  
Setup Programs?

SELECT PROGRAM  
Program Part 1?

### 6.2.1.3 - How to go into Part 2 mode Setting

#### LCD Remote Keypad:

- Under Engineer mode.
- Press **1** **PRCG** to Select **Setup Programs**.
- Press **3** **PRCG** to accept and go into **Program Part 2**.

LC ENGINEER MENU  
Setup Programs?

SELECT PROGRAM  
Program Part 2?

### 6.2.1.4 - How to set zone function

In **Zone Function**, Security type zones can be assigned different functions. These are **1= Immediate Zone, 2 = Timed Zone, 3 = Inhibited Zone, 0 = Not Used**.

#### **Immediate (Alarm) Zone:**

Use this function when the zone is not part of an entry/exit route. When the system is **SET**, activation of an immediate zone will cause a full alarm condition.

#### **Timed (Entry/Exit) Zone:**

A time zone would be used to protect an entry/exit route. Opening the door or triggering the sensor in this type of zone when the system is **SET** will start the entry timer.

#### **Inhibited (Walkthrough) Zone:**

A time-inhibited zone operates as an immediate zone unless a timed zone has been operated and a timer started. Such a zone should be utilized to allow passage between the entry/exit door and the keypad when there are detectors present.

#### **Not Used:**

If the zone set as a not used zone. When the system is **SET**, activation of the zone will not cause a full alarm condition

**LCD Remote Keypad:**

Under Engineer Menu/Setup Program, the program mode is chosen.

• Press **1** **PRCG** go into **zone functions** function.

**SETUP PROGRAM  
Zone Functions?**

• Select Zone No. using **OMT** or **&** key.

**SELECT ZONE  
Z1: Zone 1 name?**

Note: Zone No. not displayed means this zone isn't selected "Security"

Under <Engineer Menu / Setup Zones Type / Type> p.23

• Press **PRCG** to accept. Display zone current function.

**Zone Function  
Immediate zone?**

• If press **1** to select **Immediate zone** function.

**Zone Function  
Immediate zone?**

• If press **2** to select **Timed zone** function.

**Zone Function  
Timed zone?**

• If press **3** to select **Inhibited zone** function.

**Zone Function  
Inhibited zone?**

• If press **0** to select **Not used** function.

**Zone Function  
Not used?**

• Press **PRCG** to accept and return to next zone option or press **RESET** to cancel and exit.

**SELECT ZONE  
Z2: Zone 2 name?**

**6.2.1.5 - How to set Exit mode function**

There are four selections for **Exit Mode** in all mode: **1 = Timed Exit**, **2 = Final Door**, **3 = Silent Exit**, **4 = Terminated**, **0 = Disable**.

**Timed Exit:**

A timed program will set once the exit timer has expired and all zones are clear.

**Final Door:**

A final door program will set 5 seconds after the final door has been opened and closed.

**Silent Exit:**

This operates exactly the same as **Timed Exit** but completely silent without internal sounder signal.

**Terminated:**

A terminated program will set once the PTS terminal has been trigger.

**Disable:**

A disabled program is not available for use and cannot be selected and setting time.

**LCD Remote Keypad:**

Under Engineer Menu/Setup Program, the program mode is chosen.

- Press **2** go into **Exit mode** function.
- Press **PROG** to accept. Display current exit mode function.
- If press **1** to select **Timed exit** function.
- If press **2** to select **Final door** function.
- If press **3** to select **Silent exit** function.
- If press **4** to select **Terminated** function.
- If press **0** to select **Disabled** function.
- Press **PROG** to save the exit mode that you selected above, or press **RESET** to cancel, it will exit and go to “Exit Time”.

**SETUP PROGRAM**  
**Exit Mode?**

**SELECT EXIT MODE**  
**Timed exit?**

**SELECT EXIT MODE**  
**Timed exit?**

**SELECT EXIT MODE**  
**Final door?**

**SELECT EXIT MODE**  
**Silent exit?**

**SELECT EXIT MODE**  
**Terminated?**

**SELECT EXIT MODE**  
**Disabled?**

**SETUP PROGRAM**  
**Exit Time?**

**6.2.1.6 - How to set Exit time function**

This is the time allowed to leave the premises via the exit route before the system sets. The programmable range is 00-99 seconds.

If the **Exit Time** is interrupted with the last 10 seconds, then the **Exit Time** will restart at 10 seconds after the interruption has cleared.

The default is 45 seconds.

**LCD Remote Keypad:**

Under Engineer Menu/Setup Program, the program mode is chosen.

- Press **3** to select **Exit Time** function.
- Press **PROG** to accept. Display current exit time number.

Set the time by pressing number key. The range is 00-99.  
eg. Set the exit time 20 seconds.

- Press **2** number key, cursor move to next a char.

**SETUP PROGRAM**  
**Exit Time?**

**Exit Time**  
**? 45**

**Exit Time**  
**? 25**

- Then press **0** number key, cursor move to next a char.

Exit Time  
? 20\_

- Press **PROG** to save it, or press **RESET** to cancel, it will exit and go to “Entry Time”.

SETUP PROGRAM  
Entry Time?

### 6.2.1.7 - How to set Entry time function

This is the time allowed to enter the premises via the entry route and unset the system. The programmable range is 00-99 seconds. The default is 45 seconds.

#### LCD Remote Keypad:

Under Engineer Menu/Setup Program, the program mode is chosen.

- Press **4** go into **Entry Time** function.

SETUP PROGRAM  
Entry Time?

- Press **PROG** to accept. Display current exit time number.

Entry Time  
? 45

Set the time by pressing number key. The range is 00-99.

eg. Set the entry time 20 seconds.

- Press **2** number key, cursor move to next a char.

Entry Time  
? 2\_

- Then press **0** number key, cursor move to next a char.

Entry Time  
? 20\_

- Press **PROG** to accept or press **RESET** to cancel. It goes to next program mode, if the current mode is “**Program Part 2**”, it will leave “**Setup Programs**” and go to next menu “**Setup Zone Type**”.

LC ENGINEER MENU  
Setup Zones Type?

## 6.2.2 - Setup Zones Type

The ‘Setup Zones Type’ contains: 1 = Zone name, 2 = Zone type.

### 6.2.2.1 - How to set Zone Name

This option allows each of the ten zones to be given a name.

e.g. Change zone 5 name to Bedroom 1.

**LCD Remote Keypad:**

Under Engineer Menu.

- Press **2** to select **Setup Zone Type** function.

**SETUP PROGRAM**  
**Setup Zone Type?**

- Press **PROG** to accept.

**SELECT ZONE**  
**Zone 1?**

- Press **5** **PROG** keys to select zone 5.

Note: **1** =zone 1, **2** =zone 2, ... **0** = zone 10

**SELECT ZONE TYPE**  
**Name?**

- Press **1** **PROG** keys go into setup zone name function.

**ZONE NAME**  
**? Zone 5\_**

Press **&** key, it will clear the last character.

**ZONE NAME**  
**? Zone \_**

- Press **OMT** key, it will clear the line text.

**ZONE NAME**  
**? \_**

[0]..[9] key have different characters.

**0** \_0    **1** ,)?1    **2** abc2    **3** def3

**4** ghi4    **5** jkl5    **6** mno6    **7** pqr7

**8** tuv8    **9** wxyz9

- Press **2** key twice within 3 seconds, 'B' can be shown on LCD.

**ZONE NAME**  
**? B\_**

- Press **SET** key, it will toggles capitals (exchange between capital and lowercase), ABC-abc. default input capital character.

**ZONE NAME**  
**? Be\_**

- Press **3** key twice within 3 seconds, 'e' can be shown on LCD.

**ZONE NAME**  
**? Bedroom 1\_**

- Input "Bedroom 1" string.

- Press **PROG** key to accept input and save the text,

- Press **RESET** key will exit without change to the text.

**SELECT ZONE TYPE**  
**Type?**



### 6.2.2.2 - How to set Zone Type

There are six types for Zone: **1 = Security, 2 = PA, 3 = Door Bell, 4 = Fire, 5 = Tamper/24H, 0 = Not Used.**

#### Security:

A Security Zone is only active when the system is set. The system comes supplied with service links fitted to the zone terminals to simulate a closed circuit. As each zone is connected these links should be removed. All zone are fully programmable.

#### PA:

A Personal Attack Zone is always active. A Zone may be programmed for audible PA should be wire in series.

#### Door Bell:

This feature can be programmed into any Zone. A doorbell will not operate whilst the entry/exit timers have started, when the system is in full alarm condition or whilst in programming mode.

#### Fire:

If you choose to utilize a zone as a fire zone then no other detectors may be wired into this zone. Therefore a zone cannot be both fire and intruder.

#### Tamper/24H:

Provides 24 hour monitoring.

#### Not used

A zone may be programmed for Not used, then is ignored by the panel.

To operate the Setup Zone type as follow.

e.g. Change zone 5 type to Fire zone.

#### LCD Remote Keypad:

Under Engineer Menu.

• Press **2** **PROG** keys go into **Setup Zone Type** function.

**SETUP PROGRAM**  
**Setup Zone Type?**

• Press **5** **PROG** keys to select zone 5.

**SELECT ZONE**  
**Zone 1?**

Note: **1** =zone 1, **2** =zone 2, ... **0** = zone 10

• Press **2** key to select setup zone type function.

**SETUP ZONE TYPE**  
**Type?**

• Press **PROG** key to go into Select Zone Type function.

**SELECT ZONE TYPE**  
**Security?**

• Press **4** key to select Fire zone type.

**SELECT ZONE TYPE**  
**Fire?**

- Press **PROG** to save, or press **RESET** to cancel. it goes to next Zone.
- If the Zone is “**Zone 10**”, it will leave “**Setup Zone type**” and go to next menu “**Setup Zone Attributes**”.

### 6.2.3 - Setup Zones Attributes

There are three attributes for Zones: 1 = Omit Allowed, 2 = Double Knock, 3 = Chime. You can set it ON or OFF.

#### Omit Allowed:

When a Zone is programmed as Omit Allowed, the panel allows the Zone to be omitted for one set period by the user when setting the system.

**Note: The zone must be a security zone for it to be programmed as omit allowed.**

#### Double Knock:

Double knock programming is used when zones are likely to create false activations.

Double knock requires two activations within 10 minutes of the same Zone or a Zone left open for 10 seconds.

#### Chime:

If a Security Zone is programmed as Chime, then chime tone is activated when it is triggered in DAY mode.

**Note: The zone must be a security zone for it to be programmed as Chime.**

To operate the Setup Zone attributes as follow.

e.g. Set zone 2 have Omit Allowed, Double Knock and Chime attributes (set ON).

#### LCD Remote Keypad:

Under Engineer Menu.

- Press **3** **PROG** keys go into **Setup Zone Attribute** function.

- Press **2** **PROG** keys to select zone 2.

Note: **1** =zone 1, **2** =zone 2, ... **0** = zone 10

- Press **1** **PROG** key to go into setup Zone Omit Allowed function

- Press **&** or **OMT** key to toggle ON/OFF,  
Press **PROG** to save, or press **RESET** to cancel.

- Press **2** **PROG** key to go into setup Zone Double Knock function

**LC ENGINEER MENU**  
**Setup Zone Attr?**





**SELECT ZONE**  
**Zone 2?**

**SELECT ATTRIBUTE**  
**Omit Allowed?**



**Omit Allowed**  
**OFF?**

**SELECT ATTRIBUTE**  
**Double Knock?**

**Double Knock**  
**OFF?**

- Press  or  key to toggle ON/OFF,  
Press  to save, or press  to cancel.

**SELECT ATTRIBUTE  
Chime?**

- Press   key to go into setup Zone Chime Attributes.

- Press  or  key to toggle ON/OFF,
- Press  to save, or press  to cancel. it goes to next Zone.

If the Zone is “**Zone 10**”, it will leave “**Setup Zone Attr**” and go to next menu “**Setup Codes**”.

**LC ENGINEER MENU  
Setup Codes?**

## 6.2.4 - Setup Codes

### 6.2.4.1 - How to set up User Code

There is a Managers code and 10 user codes that can be created and set by LCD Keypad in the system, all are 4-digit and can be set to any number from 0000 to 9999. The access codes ensure that only authorized users can operate the system.

1 = user 1, 2 = user 2, 3 = user 3, 4 = user 4, 5 = user 5, 6 = user 6, 7 = user 7,  
8 = user 8, 9 = user 9, 0 = user 10.

#### Managers Code:

The **Managers Code (default 0123)** can change all codes and has full access to the option in the user programming mode.

**Note:** The Managers Code can only be changed from the User Programming Menu.

#### User 1 – User10 codes:

The user 1 –user 10 codes have the same operation for testing and Setting and Unsetting, changing their own code.

#### Holiday code:

The purpose of this code is to allow access to the property whilst the manager is absent. The Holiday access code is programmed by the Manager and is only valid until the manager uses the system. At this point the Holiday code becomes invalid and is no longer accepted by the control panel.

#### Engineer code:

Access the Engineer program mode to allow the system to be programmed. If configured the Engineer’s code can be used to reset the system after an alarm.

**NOTE: Entering an invalid user code 4 times will operate the code tamper and lock you out. After another 5 times invalid user code, a full alarm condition will be generated.**

### 6.2.4.2 - How to change User Name

This option allows each of the users to be given a name.

**LCD Remote Keypad:**

Under Engineer Menu.

- Press **4** **PROG** keys go into **Setup Codes** function.



- Press **1** ... **9** or **0** or **ENT** or **&** key to select a code that you want to set.



Note: **1** =user 1, **2** = user 2, ... **0** = user 10

or press **&** key to select Holiday, Engineer.

- Press **PROG** to accept and go into set the user.



- Press **1** **PROG** keys go into setup change user name function.

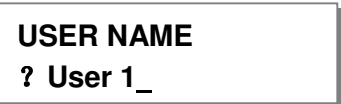

- Enter new name string.

How to input string text refer to page 22, How to set zone name.

- Press **PROG** key to accept input and save the text,
- Press **RESET** key will without change the text and exit.



**6.2.4.3 - How to change User Code**

This option allows each of the users to be given a code.

**LCD Remote Keypad:**

Under Engineer Menu.

- Press **4** **PROG** keys go into **Setup Codes** function.



- Press **1** ... **9** or **0** or **ENT** or **&** key to select a code that you want to set.



Note: **1** =user 1, **2** = user 2, ... **0** = user 10

or press **&** key to select Holiday, Engineer.

- Press **PROG** to accept and go into set the user.



- Press **2** key to select **Change Code** function.



- Press **PROG** key go into **Change Code** function.



- If the previous user code not used, then display.
- Input 4-digit, if you input error key, the error tone will be generated.
- Press **PROG** to save. If the 4-digit is the same as other codes, then display and error tone generate, press any key to leave, it goes to “Delete Code”
- Press **RESET** key will not change the code and exit.

**USER CODE**  
? \_ . . .

**Duplicate Code!**

#### 6.2.4.4 - How to delete User Code

##### LCD Remote Keypad:

Under Engineer Menu.

- Press **4** **PROG** keys go into **Setup Codes** function.
- Press **1** ... **9** or **0** or **ENT** or **&v** key to select a code that you want to set.  
Note: **1** =user 1, **2** = user 2, ... **0** = user 10  
or press **&v** key to select Holiday, Engineer.
- Press **PROG** to accept and go into set the user.
- Press **3** key to select **Delete Code** function.
- Press **PROG** key will delete the user code..
- Press any key to go to modify next code, if the code is “**Engineer codes**”, it will leave “**Setup Codes**” and go to next menu “**Setup System**”.

**SETUP PROGRAM**  
**Setup Codes?**

**SELECT CODE**  
**User 1?**

**SETUP CODE**  
**Change Name?**

**SETUP CODE**  
**Delete Code?**

**Code Deleted!**

**SETUP PROGRAM**  
**Setup System?**

## 6.2.5 - Setup system

The catalog of Setup system contains eight parts. They are list as follow:

**1 = Flags1, 2 = Flags2, 3 = Bell Time, 4 = Rearm count, 5 = Bell delay time, 6 = Set Time, 7 = Set Date, 8 = Service Date.**

### 6.2.5.1 - How to Setup System Flags

The System Flags are divided into Flags1, 2.

#### Flag1 – Options

There are eight options under Flag1 which are described below:

2=RKP PA, 3=Engineer Reset, 4=PA user Reset, 5=Fire user Reset, 6=Bell in Fire, 7=Disable Bell Tamper, 8=lock Engineer Code, 9=Exit Walk Test

#### RKP PA

When this flag is set to ON, the keypad's PA function is enabled.

#### Engineer Reset

When this flag is set to ON, an engineer code must be entered to reset the system after Tamper, PA or Fire alarm. When the flag is set to OFF the system can be reset by the user.

#### PA user Reset

When this flag is set to ON, it permits the user to reset the system after a PA alarm, by pressing user code. The user can reset the system even if the **Engineer Reset** flag is set to ON.

#### Fire user Reset

When this flag is set to ON, it permits user to reset the system after a Fire alarm by pressing user code. The user can reset the system even if the **Engineer Reset** flag is set to ON.

#### Bell in Fire

When this flag is set to ON, the external siren Bell box will sound On/two second off during the fire alarm.

#### Disable Bell Tamper

When this flag is set to ON, when the Bell Tamper is trigger in FULL, Part1, Part2 mode the alarm system will not process it.

#### Lock Engineer Code

When this flag is set to ON, the system can't reset the engineer code to default when you use "Reset NVM" command.

#### Exit Walk Test

When this flag is set to ON, it will automatically return to next option after 20 minutes.

To operate Flag 1 as follow.

Under Engineer Menu.

- Press **5** **PROG** keys go into **Setup System** function.
- Press **1** **PROG** keys go into **Setup Flags 1**
- Press **2** key to select **RKP PA** function.
- Press **3** key to select **Engineer reset** function.
- Press **4** key to select **PA user reset** function.
- Press **5** key to select **Fire user reset** function.
- Press **6** key to select **Bell in Fire** function.
- Press **7** key to select **Disable Bell Tamper** function.
- Press **8** key to select **Lock Engineer Code** function.
- Press **9** key to select **Exit Walk Test** function.
- Press **PROG** key accept be selected flag.
- Press **&** or **ENT** key to toggle ON/OFF,
- Press **PROG** to save, or press **RESET** to cancel. it goes to next flag.

**SETUP SYSTEM  
Flags 1?**

**SELECT FLAG 1  
Silent PA?**

**SELECT FLAG 1  
RKP PA?**

**SELECT FLAG 1  
Engineer reset?**

**SELECT FLAG 1  
PA user reset?**

**SELECT FLAG 1  
Fire user reset?**

**SELECT FLAG 1  
Bell in Fire?**

**SELECT FLAG 1  
Dis Bell Tamper?**

**SELECT FLAG 1  
Lock Engr Code?**

**SELECT FLAG 1  
Exit Walk Test?**

**Exit Walk Test  
OFF**

**Exit Walk Test  
ON**

**SETUP SYSTEM  
Flags 2?**

## Flag2 – Options

There are eight options under Flag2 which are described below:

1=Key switch, 2=Doorbell, 3=Strobe on Set, 4=Single key Set, 5=EN Compliant, 6=EOLR Zone  
7=Daylight Saving, 8=Service Timer

### PTS terminals used with a Keyswitch

When this flag is set to ON, this enables the system to be SET and UNSET with the use of a key switch in the PTS terminals (NO contacts = Day mode, NC contacts = Full Set). If the panel needs to be reset then a manager/user code must be entered.

### PTS as Doorbell

When this flag is set to ON, Keyswitch = OFF, the PTS terminal is programmed to a doorbell (Momentary NO contacts required i.e. bell push button), if the Keyswitch = ON, the PTS terminal is used as Keyswitch.

### Strobe on Set

When this flag is set to ON, the external strobe will stay on for five seconds once the panel has set.

### Single key Set

When this flag is set to ON, it allows the panel to be set Full mode by pressing the [Set] button, set Part 1 mode by pressing [▲] key, set Part 2 mode by pressing [▼] key. A code entry is not required. However, a 4-digit code is required to Unset the panel.

### EN Compliant

When this flag is set to ON, the alarm system has Battery Monitoring function.

### EOLR Zone

When this flag is set to ON, the alarm system goes to EOLR mode. Each detector must have a 2k2 resistor connected across its alarm contacts. In addition, a 2k2 resistor must be connected across the end of the Zone wiring, as shown in the following diagram. Note the PIR detectors usually have a “spare” terminal for this purpose.

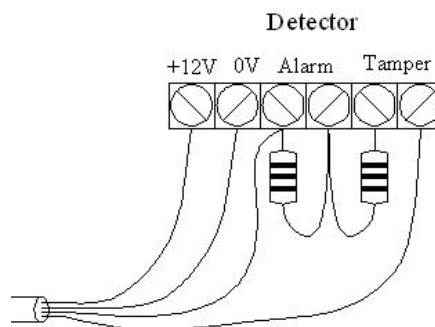

### Daylight Saving

When this flag is set to ON, the system will turn clock back 1 hour 2 am on the first Sunday in Apr and ahead 1 hour 2 am on the first Sunday in Oct.

### Service Timer

When this flag is set to ON, the user can use the alarm system during Service Time.



To operate Flag 2 as follow.

Under Engineer Menu.

- Press **5** **PROG** keys go into **Setup System** function.
- Press **2** **PROG** keys go into **Setup Flags 2**
- Press **1** key to select **Key switch** function.
- Press **2** key to select **PTS as Doorbell** function.
- Press **3** key to select **Strobe on SET** function.
- Press **4** key to select **Single key SET** function.
- Press **5** key to select **EN Compliant** function.
- Press **6** key to select **EOLR Zone** function.
- Press **7** key to select **Daylight Saving** function.
- Press **8** key to select **Service Timer** function.
- Press **PROG** key accept be selected flag.
- Press **&** or **ENT** key to toggle ON/OFF.
- Press **PROG** to save, or press **RESET** to cancel.

**SETUP SYSTEM  
Flags 1?**

**SELECT FLAG 2  
Keyswitch?**

**SELECT FLAG 2  
Keyswitch?**

**SELECT FLAG 2  
PTS as Doorbell?**

**SELECT FLAG 2  
Strobe on SET?**

**SELECT FLAG 2  
Single key SET?**

**SELECT FLAG 2  
EN Compliant?**

**SELECT FLAG 2  
EOLR Zone?**

**SELECT FLAG 2  
Daylight Saving?**

**SELECT FLAG 2  
Service Timer?**

**Service Timer  
OFF**

**Service Timer  
ON**

**SETUP SYSTEM  
Bell Time?**

### 6.2.5.2 - How to Setup Bell Time

This is the duration that the external bell output is active. The range is 01-20 minutes. The default is 14 minutes.

e.g. Change the **Bell Time** from 14 to 15 minutes.

#### LCD Remote Keypad:

Under Engineer Menu

- Press **5** **PROG** keys go into **Setup System** function.
- Press **3** to select **Bell Time** function.
- Press **PROG** to accept. Display current Bell time number.

**SETUP SYSTEM**  
**Flags 1?**

**SETUP SYSTEM**  
**Bell Time?**

**Bell Time**  
**? 14**

Set the time by pressing number key. The range is 00-20.

- Press **1** number key, cursor move to next a char.
- Then press **5** number key, cursor move to next a char.
- Press **PROG** to save it, or press **RESET** to cancel, it will exit and go to "Rearm Count".

**Bell Time**  
**? 14**

**Bell Time**  
**? 15**

**SETUP SYSTEM**  
**Rearm Count?**

### 6.2.5.3 - How to Setup Rearm count

After an alarm the panel will automatically rearm itself when the external siren (Bell) timer has expired. Any Zones and tamper, panic which still remain open at that time will be automatically omitted.

The default is 3 rearms. 0 = no rearms, 1-8= number of rearms, 9= always rearm

e.g. Change the **Rearm Count** from 3 to Always rearm.

**LCD Remote Keypad:**

Under Engineer Menu

- Press **5** **PROG** keys go into **Setup System** function.
- Press **4** to select **Rearm Count** function.
- Press **PROG** to accept. Display current Rearm count number.

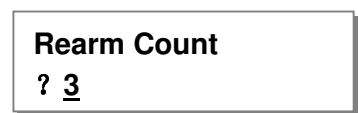
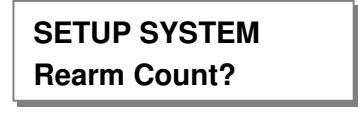
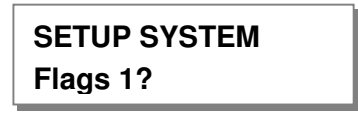

Set the Rearm count by pressing number key. The range is 0-9.

- Press **9** number key.
- Press **PROG** to save it, or press **RESET** to cancel, it will exit and go to “**Bell Delay Time**”.

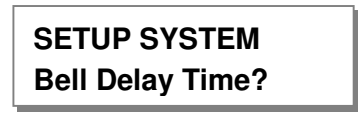
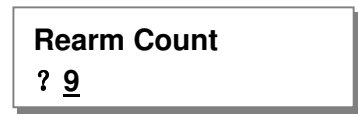

**6.2.5.4 - How to Setup Bell delay time**

This delays the activation of the Bell for the required time. The range is 00-99 minutes. The default is 00 minutes.

e.g. Change the Bell Delay time from 0 to 1 minute.

**LCD Remote Keypad:**

Under Engineer Menu

- Press **5** **PROG** keys go into **Setup System** function.
- Press **5** to select **Bell Delay Time** function.
- Press **PROG** to accept. Display current bell delay time.

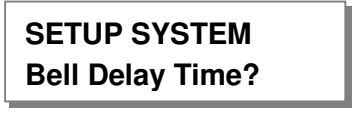
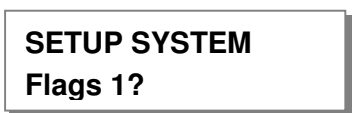

Set the bell delay time by pressing number key. The range is 00-99.

- Press **0** **1** number keys.
- Press **PROG** to save it, or press **RESET** to cancel, it will exit and go to “**Set Time**”.

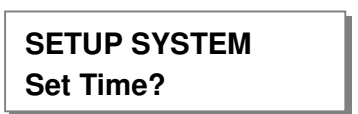

### 6.2.5.6 - How to Setup Set Time



The time can be modified in hours, minutes in the format HH:MM. you must set it correctly, or else System will generate an error tone and not save the change.  key will help you to select the bit that you want to write.

\* *Time and Date will be lost once the power supply from both main power and backup battery are cut*

e.g. Change the system time to 12:02

#### LCD Remote Keypad:

Under Engineer Menu

• Press   keys go into **Setup System** function.

SETUP SYSTEM  
Flags 1?

• Press  to select **Set Time** function.

SETUP SYSTEM  
Set Time?



• Press  to accept. Display current time.

Set Time HH:MM  
00:00

set new time to 12:02







• Press     number keys.

Set Time HH:MM  
12:02

• Press  to save it and clear second time, or press  to cancel, it will exit and go to “**Set Date**”.

SETUP SYSTEM  
Set Date?



### 6.2.5.7 - How to Setup Set Date

Before you set the date, you select day for the date that you want to set. Using  -  or  or  key to change day, pressing  key to save, pressing  key to not change. The date can be changed in day, month, year format DD/MM/YY. The method of set date is the same as how to set time.

e.g. Set current system date: Tuesday, 28-08-2009

#### LCD Remote Keypad:

Under Engineer Menu

• Press   keys go into **Setup System** function.

SETUP SYSTEM  
Flags 1?

• Press  to select **Set Date** function.

SETUP SYSTEM  
Set Date?

• Press  to accept. Display current week.

SELECT DAY  
Monday?

- Select a week day No **2** , and Press **PROG** to accept.

**SELECT DAY**  
**Tuesday?**

- Enter system date: Day/Mon/Year(6-digits)

**Date: DD/MM/YY**  
**08/08/08**

- Press **2 8 0 8 0 9** number keys.

**Date: DD/MM/YY**  
**28/08/09**

- Press **PROG** to save it, or press **RESET** to cancel, it will exit and go to “**Service Date**”.

**SETUP SYSTEM**  
**Service Date?**

### 6.2.5.8 - How to Setup Service Date

You can use the alarm system before the Service data. The date can be changed in day, month, year format DD/MM/YY. The method of set date is the same as how to set time.

e.g. Set current system date: Tuesday, 30-12-2010

#### LCD Remote Keypad:

Under Engineer Menu

- Press **5** **PROG** keys go into **Setup System** function.

**SETUP SYSTEM**  
**Flags 1?**

- Press **8** to select **Service Date** function and **PROG** to save it,

**SETUP SYSTEM**  
**Service Date?**

- Enter system date: Day/Mon/Year(6-digits)

**Date: DD/MM/YY**  
**01/01/09**

- Press **3 0 1 2 1 0** number keys.

**Date: DD/MM/YY**  
**30/12/10**

- Press **PROG** to save it, or press **RESET** to cancel, it will exit and go to “**Misc Menu**”.

**LC ENGINEER MENU**  
**Misc Menu?**

### 6.2.6 - Misc menu

“Misc menu” is divided into four parts:

**1 = Show help, 2 = Challenger Tel, 3 = Alarm Co. Info, 4 = Reset NVM.**

### 6.2.6.1 - How to Show Help file

It guides you to use the function key in different operation.

#### LCD Remote Keypad:

Under Engineer Menu

- Press **6** **PROG** keys go into **Misc Menu** function.
- Press **1** **PROG** keys go into **Show help** function.
- Press **&** key show next page.
- Press **RESET** to cancel at any time, it will exit and go to “**Challenger Tel**”. Else help file finish will exit.

**LC ENGINEER MENU**  
**Misc Menu?**



**MISC MENU**  
**Show help?**

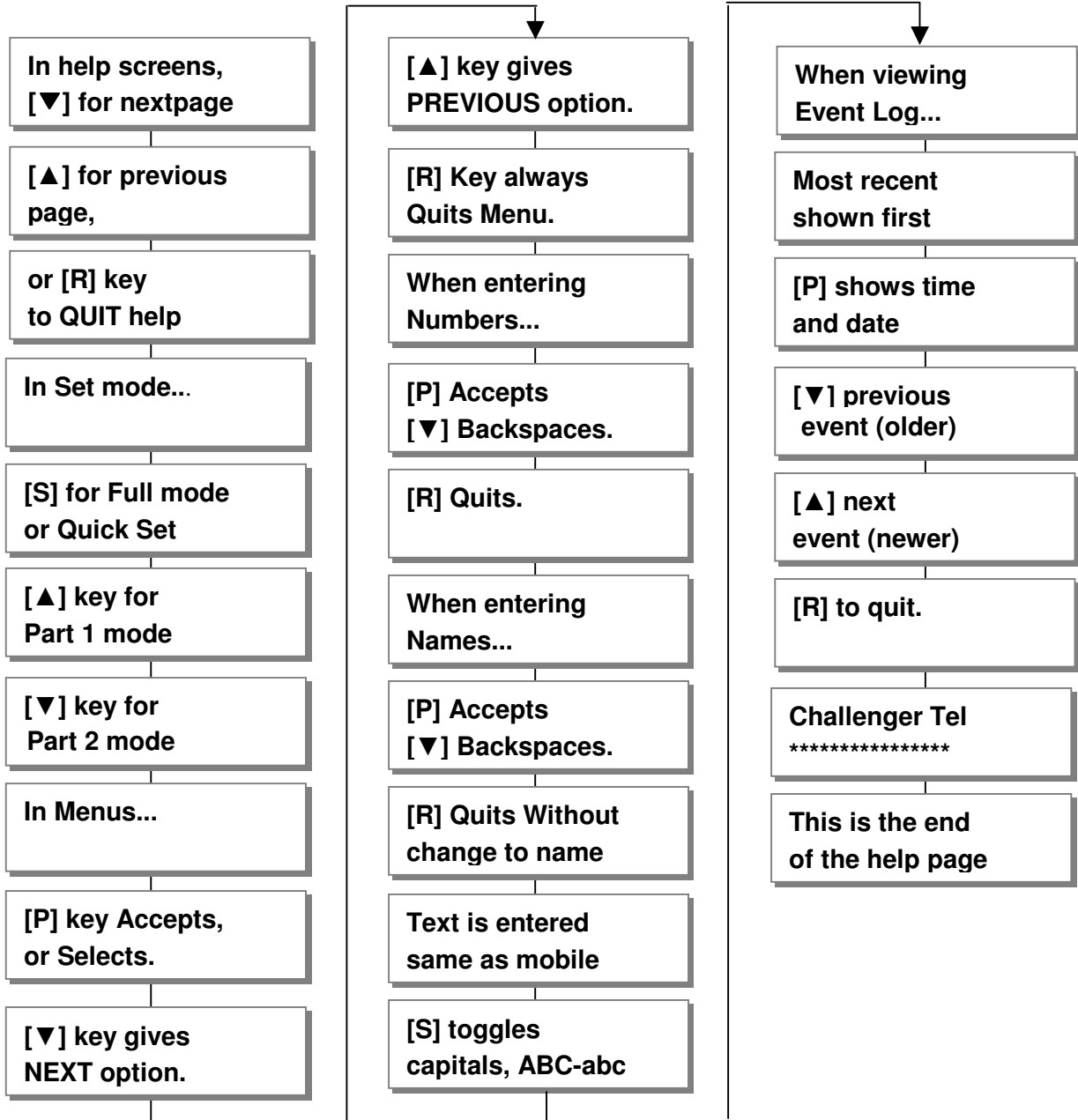

**In help screens,**  
**[▼] for nextpage**

**MISC MENU**  
**Challenger Tel?**

• Help file as follow:



Note: [P] using  key, [R] using  key, [S] using  key,

[▲] using  key, [▼] using  key.

### 6.2.6.2 - How to Show Challenger Telephone

It records the company telephone number that you buy the alarm system from.

**LCD Remote Keypad:**

Under Engineer Menu

- Press **6** **PROG** keys go into **Misc Menu** function.
- Press **2** key to select **Challenger Tel** function.
- Press **PROG** key show Challenger Telephone.
- Press any key will exit and go to **“Alarm Co. Info”**.

LC ENGINEER MENU  
Misc Menu?

MISC MENU  
Challenger Tel?

Challenger Tel  
\*\*\*\*\*

MISC MENU  
Alarm Co. Info?

### 6.2.6.3 - How to modify alarm company information

You can write two lines of the information about your company in this menu. The max number of characters in one line is 14, so you can write 28 chars most in **“Alarm Co. Info”**

**LCD Remote Keypad:**

Under Engineer Menu

- Press **6** **PROG** keys go into **Misc Menu** function.
- Press **3** key to select **Alarm Co. Info** function.
- Press **PROG** key show Challenger Telephone.
- Enter new string . e.g. input **“Challenger”**.  
How to input string text refer to page.22 , How to set zone name.
- Press **PROG** key to accept input and save the text,  
Press **RESET** key to cancel and go to next option.
- Enter new string **“10 Zone System”**.  
How to input string text refer to page.22 , How to set zone name.
- Press **PROG** key to accept input and save the text,  
Press **RESET** key to cancel and exit.

LC ENGINEER MENU  
Misc Menu?

MISC MENU  
Alarm Co. Info?

First Line Text  
?\_

First Line Text  
?Challenger\_

Second Line Text  
?\_

Second Line Text  
?10 Zone System\_

MISC MENU  
Reset NVM?



### 6.2.6.4 - How to Restore the factory default setting using the menu

You will change the value of all parameters to factory default value when you set it.

**CAUTION:** All configurations of the panel are reset to reset to factory default conditions.

To default to factory settings:

#### LCD Remote Keypad :

- Under Engineer menu
- Press **6** **PROG** go into **MISC MENU**
- Press **4** to select **Reset NVM** function
- Press **PROG** go into Reset NVM function.
- Press **PROG** to accept and system will generate an extended acceptance tone.
- Finished and return to next option.

**LC ENGINEER MENU**  
**Setup Program?**

**MISC MENU**  
**Show Help?**

**MISC MENU**  
**Reset NVM?**

**Are you sure?**  
**Press P for yes**



Extended acceptance tone

**LC ENGINEER MENU**  
**View Event Log?**

**NOTE:** if Lock Engineer flag is ON, Engineer Code cannot reset to factory default

### 6.2.7 - View Event Log

The event log gives a display of all the events that have taken place. The events are arranged by date and time. Up to 250 events can be stored in the memory. When the log reaches 250 events and another event takes place, the first event drops out. The system is known as FILO (First In Last Out).





To view the event log:

#### LCD Remote Keypad :

- Under Engineer menu
- Press **7** key to select **View Event Log** function.
- Press **PROG** to accept and most recent event shown first.

**LC ENGINEER MENU**  
**View Event Log?**

**Code Change**  
**05:User 5**

- View other event log using  or  key.
- View event happen time and date using  key.
- Press any key to return the currently event log when you view the time and data of it.
- Press  to accept and system will generate an extended acceptance tone. or press  key to leave
- Finished and return to next option.

Code Change  
04:User 4

Time : 00 : 28  
Date : 08 - Aug

Code Change  
04:User 4

LC ENGINEER MENU  
Test System?







## 6.2.8 - Test System

This function has four parts in Test System: **Test output, Walk Test, View Walk Test, Panel Version.**

### 6.2.8.1 - How to Test Outputs

The basic test outputs are: **0 = BELL, 1 = Strobe, 2 = Speaker,**

#### LCD Remote Keypad :

- Under Engineer menu
- Press  key to select **Test System** function.
- Press  key go into test system bell item.
- Press  key to select Bell output test.
- If press  key to select Strobe output test.
- If press  key to select speaker output test.
- Press  key to accept and The toggle test outputs ON, or press  key , it will leave the menu “Test System”.
- Press any key stop output and menu return to next test option. If the test output is “Abort”, it will go to “Walk Test”.

LC ENGINEER MENU  
Test System?

TEST SYSTEM  
Bell?

TEST SYSTEM  
Bell?

TEST SYSTEM  
Strobe?

TEST SYSTEM  
Speaker?

BELL is ON  
Press any key

TEST SYSTEM  
Walk Test?

### 6.2.8.2 - How to enter Walk Test

The walk test function allows check each Zone trigger, Zone tamper, Detect Tamper, Control panel tamper, Bell Box tamper, Remote Keypad tamper. in order to verify that they are functioning correctly. A tone is generated as each zone or tamper is activated (opened).

e.g. Trigger Zone and Zone tamper

#### LCD Remote Keypad :

- Under Engineer code
- Press **8** **PRCG** keys go into **Test System** function.
  
- Press **8** key to select **Walk Test** function.
  
- Press **PRCG** key go into walk test.
  
- Trigger zone 1, the toggle Zone will display in LCD, if it isn't displayed, to check the Zone that you trigger.
- Trigger zone 1 tamper, the toggle Tamper will display in LCD, if it isn't displayed, to check the Tamper that you trigger.
- Trigger Control panel tamper, the toggle Tamper will display in LCD, if it isn't displayed, to check the Tamper that you trigger.
  
- Press any key to exit "**Walk Test**", then you can view walk Test. Or when '**Exit Walk Test**' = ON, it will automatically exit after 20 minutes.

**TEST SYSTEM**  
**Bell?**

**TEST SYSTEM**  
**Walk Test?**

**Walk Test**

**Zone Tested**  
**Z1:Zone 1**

**Zone Tamper**  
**Z1: Zone 1**

**CP Tamper**

**TEST SYSTEM**  
**View Walk Test?**

### 6.2.8.3 - How to enter View Walk Test

To operate the "**View Walk Test**" as follow:



#### LCD Remote Keypad :

- Under Engineer code
- Press **8** **PRCG** keys go into **Test System** function.
  
- Press **9** key to select **Walk Test** function.
  
- Press **PRCG** key go into walk test.

**TEST SYSTEM**  
**Bell?**

**TEST SYSTEM**  
**View Walk Test?**

**Zone Tested**  
**Z1:Zone 1**

- Press  key to see the next news
- when you see “**Finished**” press  key to exit.  
or Press  key to exit.

**Zone Tamper**  
**Z1:Zone 1**

**Finished?**





#### 6.2.8.4 - How to enter View Panel Version

##### Panel Version

The version of software in this panel.

To operate the view “Panel Version” as follow:

##### LCD Remote Keypad :

- Under Engineer menu
- Press   keys go into **Test System** function.
- Using  key to select **Panel Version** item.
- Press  key to view the software version.
- Press any key to leave “**TEST SYSTEM**” .
- Press  key to exit engineer program mode.

**TEST SYSTEM**  
**Bell?**



**TEST SYSTEM**  
**Panel Version?**

**Software Version**  
**2.0**

**LC ENGINEER MENU**  
**Setup Programs?**

#### 6.2.8.5 - How to Exit Engineer Program Menu

##### LCD Remote Keypad :

- Under Engineer menu.
- Press  key return to top of engineer menu.
- Press  key to exit engineer program mode.  
and check system faults (all Tamper, TA zone, PA zone,  
Fire zone is open)
- When no fault, press any key to exit.
- LCD show DAY mode.

**LC ENGINEER MENU**  
**Setup Programs?**

**Checking for**  
**Faults...**

**No Fault**  
**Press any key**

**00:28:08 08-Aug**  
**DAY**

## Section 7 - Using System

After you have finished system settings, you can then use the system. This section gives an operation of how to set and unset the system as well as how to reset after an alarm.

### 7.1 – LED Keypad

#### 7.1.1 - Setting the System

The panel has three programs: Program Full, Program Part1, Part2. Each can be programmed independently in the Engineer operations mode. So you can set the system to the corresponding mode: **Full Mode, Part1 Mode and Part2 mode**. You can set them as follows.

##### LED Remote Keypad :

- System is in Day mode and supply power 1 minute later.

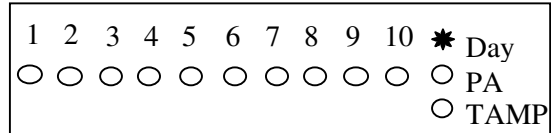

- Enter User code/Manager code   
Day LED will flash 5 second, then you can select arm mode.

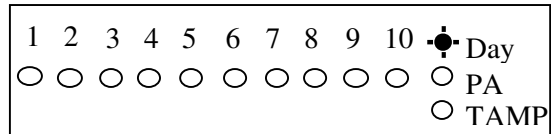

- Press key to select Full arm mode,  
Or press key to select Part 1 arm mode,  
Or press key to select Part 2 arm mode.  
Or press key to exit.

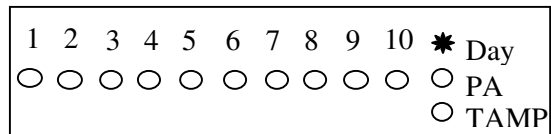

- If it has faults in system, you can see the fault from LED and the fault tone will be generated, you should to solve the fault to entry the mode e.g. Detector 1 activated.

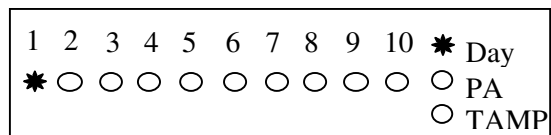

Exit error beep

- Press key quick set the system.(Optional)

Count down beep

- After the system has armed the Day LED will not be lit.

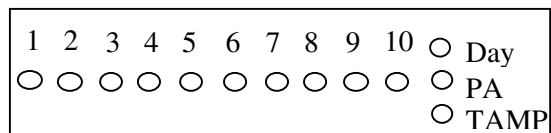

## 7.1.2 - How to OMIT a zone(s)

If you cannot set the alarm system because a detector is faulty and in constant alarm you may need to omit its zone from the alarm system. A zone which has been omitted cannot cause an alarm. Omitted zones will be restored after the system is unset.

Before a zone can be omitted it has to be enabled by the engineer as “Setup zone attrs/Omit Allowed” zone.

### LED Remote Keypad :

- System work in setting mode, add the set mode is chosen. (for more information see “How to Setting the System”)

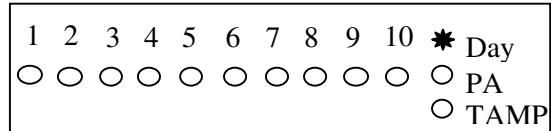

- Press **OMIT** key to go into omit zone window, and all allowed zones to be omit will light. e.g. To omit zone 4

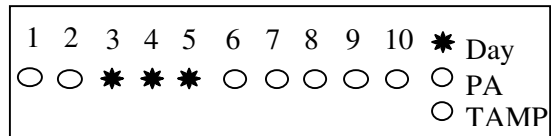

Press **4** to omit zone 4, the corresponding LED OFF  
Press same key to toggle ON/OFF.

Note: 1-9 key= zone1 –zone 9, 0 key = zone 10.

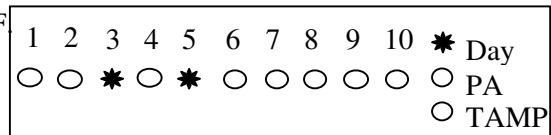

- Press **PROG** key to accept and continue setting or press **RESET** key to cancel omit function.

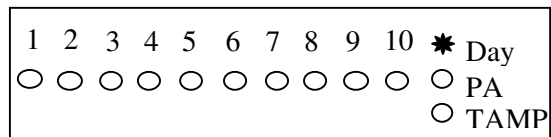

- System work in setting mode

## 7.1.3 - Unsetting the System

To unset the system.

### LED Remote Keypad :

- System is Set.

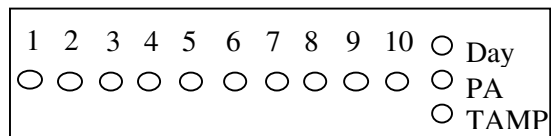

- Enter User code/Manager code **???**  
System returns to Day mode.

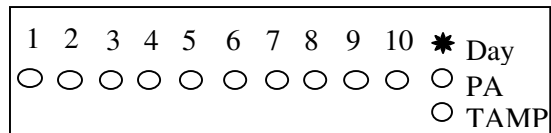

CAUTION: Entering an invalid user code will operate the code tamper. After 9 incorrect keys pushes a full alarm condition will be generated.

## 7.1.4 - How to UNSET from Alarm and RESET the system

You can unset the system in SET and reset it after an alarm, Tamper or PA.

The system will be programmed to be reset by the user or engineer. This is dependent on System flags set up. See **Engineer mode / Setup System/ Flags 1.**

e.g. Control Panel tamper trigger alarm

### LED Remote Keypad :

- System is in Set mode.

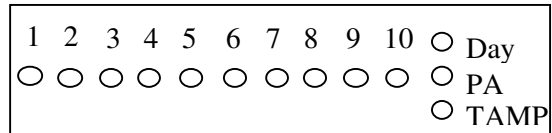

- Enter User code/Manager code ( ? ) ( ? ) ( ? ) ( ? )

It will stop system in alarm and the LED keypad will hint of alarm event. First event is flashing, other lit.

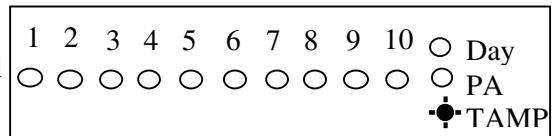

- Enter User code/Manager code ( ? ) ( ? ) ( ? ) ( ? )

System returns to Day mode.

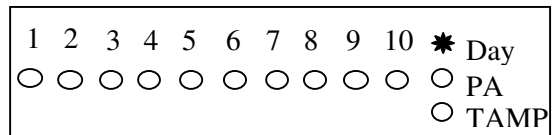

## 7.1.5 - How to use Panic Alarm on keypad

Should you need to attract attention, the full alarm signal can be activated at emergency by pressing 0 and 5 together

Press ( 0 ) & ( 5 ) simultaneously, the system and external sounder will sound immediately.

### Note:

**This flag is factory default on.**

## 7.2 - LCD Keypad

### 7.2.1 - Setting the System

The panel has three programs: Program Full, Program Part1, Part2. Each can be programmed independently in the Engineer operations mode. So you can set the system to the corresponding mode: **Full Mode, Part1 Mode and Part2 mode**. You can set them as follows.

#### LCD Remote Keypad :

- System is in Day mode and supply power 1 minute later.

00:01:00 08-Aug  
DAY

- Enter 4-digit manager or user code and wait later.

e.g. press 0 1 2 3

Enter your code  
\*\*\*

- the display will show user (i.e. manager).

===Welcome===  
Manager

- Within 3 seconds select the appropriate arming mode

Press  key to select Full arm mode,

Or press  key to select Part 1 arm mode,

Or press  key to select Part 2 arm mode.

Or press  key to exit.

To Set Select  
[Full] [P1] [P2]

- Exit and check system faults.

System fault contains: Tamper Zone, PA Zone, Fire Zone, Zone N tamper (when EOLR function enable), CP tamper, Detect Tamper, RKP Tamper, Bell Box Tamper

- If the system has a fault this will be displayed on LCD display and the fault tone will be generated.

Exit Faults...  
Z1:Zone 1

e.g. Detect 1 activated.

 Exit error beep

- When no fault, it will display “Exit–No Faults” and the exit tone will be generated, it is going to the mode that you selected until the exit time is end, if press  key will quick set the system.

 Count down beep

- Arm mode is set.

00:01:45 08-Aug

**Note:** “To Set Select \*\*\*\* ” will be displayed the mode that you set not to disable in *Engineer Mode/ Setup Programs/ Exit mode*.

### 7.2.2 - How to OMIT a zone(s)

If you cannot set the alarm system because a detector is faulty and in constant alarm you may





need to omit its zone from the alarm system. A zone which has been omitted cannot cause an alarm. Omitted zones will be restored after the system is unset.



Before a zone can be omitted it has to be enabled by the engineer as “Setup zone attrs/Omit Allowed” zone.

**LCD Remote Keypad :**

- System work in setting mode, select the set mode is required . ( for more information see “How to Setting the System”)

- Press  key to go into omit zone window, and display first omit allowed zone.

- Select a omit allowed zone using  or  key.

- Press  key to accept and continue setting or press  key to cancel omit function.

- System work in setting mode

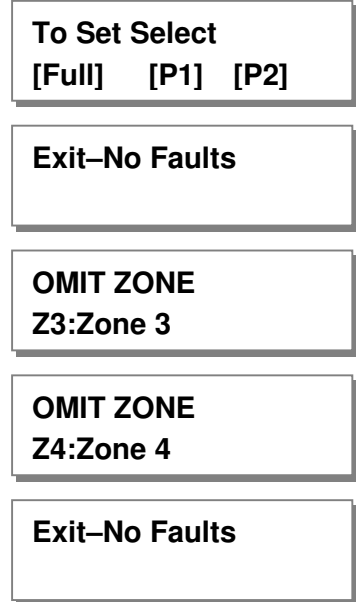



**7.2.3 - Unsetting the System**

To unsetting the system in SET as follows.

**LCD Remote Keypad :**

- System is in the SET mode

- Input 4-digit manager or user code. e.g. press    

- Hint manager unset 3 seconds.

- System will be reset and work in DAY mode.

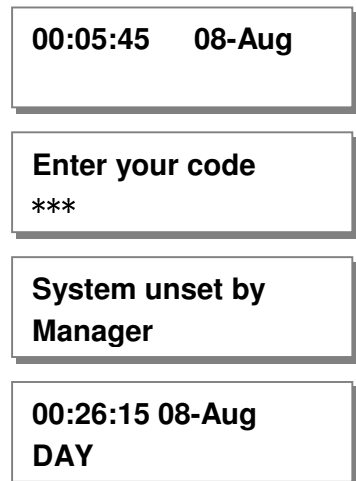

CAUTION: Entering an invalid user code will operate the code tamper. After 9 incorrect keys pushes a full alarm condition will be generated.

**7.2.4 - How to UNSET from Alarm and RESET the system**

You can unset the system in SET and reset it after an alarm, Tamper or PA.

The system will be programmed to be reset by the user or engineer. This is dependent on System flags set up. See **Engineer mode / Setup System/ Flags 1.**

e.g. Control Panel tamper trigger alarm

**LCD Remote Keypad :**

- System work in SET mode

- Enter manager / user code

e.g. press 0 1 2 3 (manager code)

- It will stop system in alarm and the LCD keypad will display the message of newest alarm event.

Hint (the display will scroll the following two screens)

- Enter manager/ user/ engineer code reset. ? ? ? ?

- Day mode

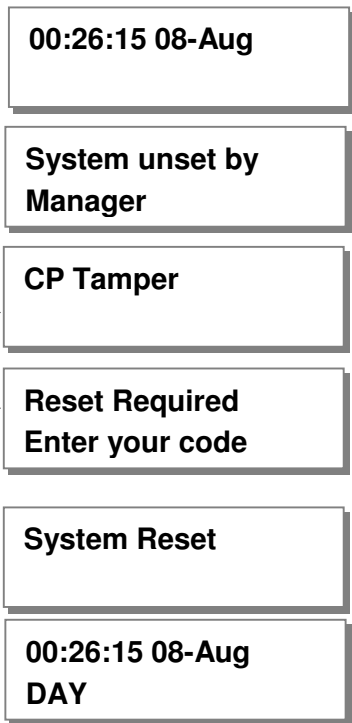

**7.2.5 - How to use Panic Alarm on keypad**

Should you need to attract attention, the full alarm signal can be activated at emergency by pressing 0 and 5 together

Press 0 & 5 simultaneously, the system and external sounder will sound immediately.

**Note:**

**This flag is factory default on.**

## Section 8 - Maintenance

*Once every three months,*

- Test all detectors.
- Check loudspeaker of control unit.
- Test sirens and strobes of the bell box.

*Additionally, once every year,*

- Check external bell box
- Test detector feature

*Additionally, once every three years,*

- Replace the rechargeable battery in the Control Unit.

## Section 9 - Troubleshooting Guide

### Control Unit (CU)

Symptoms	Possible cause & cures
Power indicator off. Key pad not responding.	No power supply to unit. Check connectors to mains and backup battery.
Power indicator does not light up but the RKP is working.	Main supply is out. It is operating from backup battery. Check power connections/adaptor.
TAMPER	Tamper triggered, check tampers (panel, keypad, detectors, bell box). Or Low backup battery condition; check battery fuse. Replace panel battery as soon as possible.
No response to detectors	Check if Links are across used zones.. Remove them.
No response to keystroke	Power reset (both mains and backup battery)

### Remote Keypad (RKP)

Symptoms	Possible cause & cures
Keypad not working.	Check the connection, check keypad address.
Keypads not working one at a time.	Check address jumper in the back PCB of keypad.

**Remark:** If you have any problem with the alarm system. To default to factory settings, please follow sections 5 explained in this manual.

## LED System Faults/Troubleshooting

### Control Panel





When system flag, EN Compliant flag is ON, There are 2 possible faults:

In Day mode the flashing Tamper LED indicates a fault. Entry of a valid code will show up to 2 LEDs flashing, prompting the user to accept the fault by pressing the  key.

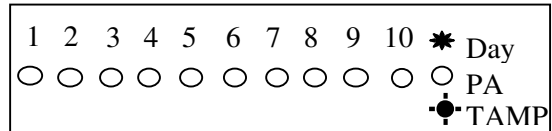
### Mains Fail

- System is in Day mode.  
Day LED ON, TAMP LED flashing.



- Enter User code / Manager code      
Show TAMP LED, Z1 LED flashing.

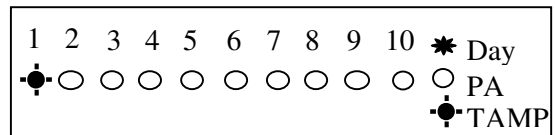



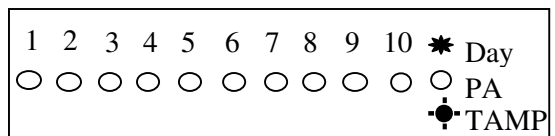

- Press  key to accept the fault.



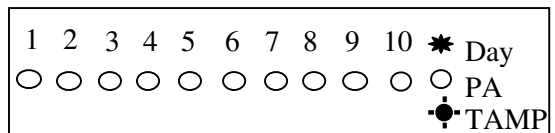

### Low Battery Volts

- System is in Day mode.  
Day LED ON, TAMP LED flashing.

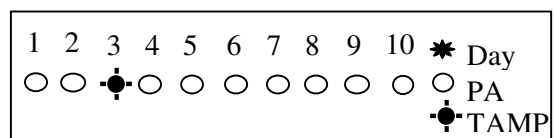

- Enter User code/Manager code      
Show TAMP LED, Z3 LED flashing.



- Press  key to accept the fault.

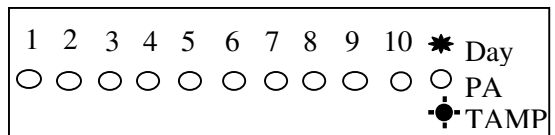

### Key Board Lockout

When you enter 4 invalid codes in succession the keypad will lockout for 90 seconds.

If another 4 subsequent invalid codes are entered then the keypad will lockout for 90 seconds.

If another invalid code is entered again in succession the system will go in to alarm condition.

## Section 10 - Specifications

<b>10 ZONE OFF-BOARD CONTROL PANEL</b>	
Type of Alarm Panel	Microprocessor based control unit
Housing	Polycarbonate
Entry Delay	default 45 seconds, programmable
Exit Delay	default 45 seconds, programmable
Alarm Zone	10 Zones - Programmable function
Remote Keypad	Up to 4 LCD / LED Keypads
Tamper	-Ve loop
External Bell box output	DC12V, max current : 400mA, adjustable timer( 1-20 mins)
Strobe output	DC12V latching
External Speaker	16ohm, max current : 230mA
Set+ output	0V in Day mode 13V in Set mode
Siren Duration	Default 14 minutes
Current consumption control panel	Standby : 50mA Alarm : 100mA
Current consumption for LCD keypad	Standby : 60mA Alarm : 100mA
Current consumption for LED keypad	Standby : 40mA Alarm : 70mA
Rechargeable battery voltage output	13.8V DC stabilized(+/- 5%) up to 350mA
Rechargeable battery	DC12V, up to 2.1Ah
Charge Voltage	13.8V dc
Battery fuse on control panel	1.6A 20mm quick blow
Aux & Bell fuse on control panel	1A 20mm quick blow
Main input fuse	125mA 20mm A/S
Total Current output	1A when supported by a fully charged battery
Mains supply voltage	230V AC (+/- 10%) 50Hz max load 0.5A
Ambient operating temperature	0°C ~ 40°C
Dimensions (mm)	253 x 195 x 61

<b>LCD REMOTE KEYPAD</b>	
Type	Remote keypad with LCD display
Housing	ABS
Operational Voltage	DC13V
Dimensions	130 x 90 x 30
Connection length	100 m

<b>LED REMOTE KEYPAD</b>	
Type	Remote keypad with LEDs indicator
Housing	ABS
Operational Voltage	DC13V
Dimensions	130 x 90 x 30
Connection length	100 m

## Appendix 1 – Event Log Messages

Keypad text	Description
Power up	Supply power on
Engineer Start	Enter engineer program mode
Engineer End	Leaving engineer program mode
Code Change	User N code be changed
Battery Low	Battery low voltage
AC Mains Failed	Mains power supply failure
AC Mains OK	Mains power supply restored
Battery OK	Battery voltage normal
Service Due	Service Time expired
Program SET	User has set the system with program Full. Part 1, or Part 2
System SET	System into Set mode
System Unset	User has unset the system
Key SET	Keyswitch set the system
Key Unset	Keyswitch unset the system
Unset from Alarm	User has unset the system from alarm
Intruder Alarm	Intruder zone activated (opened)
Entry Start	Entry time started
Entry Deviate	Entry time Deviate ( Immediate zone activated)
PANIC Alarm	Panic zone activated (opened)
Fire Alarm	Fire zone activated (opened)
RKP Tamper	RKP tamper opened
Detect Tamper	Detect tamper opened
CP Tamper	Control panel tamper opened
Bell Box Tamper	Bell box tamper opened
Code Tamper	Invalid user code was entered
Tamper Alarm Zn: Zone n	24h/Tamper zone activated (opened)
Zone Tamper Zn: Zone n	EOLR Zone tamper opened

## Appendix 2 – Zone – Location & Programming Table

Zone No:	Location	Type i.e. E/E/Alarm/PA	Full Set	Part Set 1	Part Set 2
1					
2					
3					
4					
5					
6					
7					
8					
9					
10					
<b>Exit Time</b>	/	/			
<b>Entry Time</b>	/	/			
<b>Exit Mode</b>	Timed, Final Door, Silent Exit, Terminated, Disabled	/			

	Time	<u>FLAG 1</u>	On/Off	Flag 2	On/Off
Bell Time		RKP PA		PTS as Keyswitch	
Bell Delay		Eng Reset		PTS as Door Bell	
		PA User reset		Strobe on Set	
		Fire user reset		Single Key Set	
		Bell in fire		EN Compliant	
		Disable Bell Tmp		EOLR Zone	
		Lock Eng Code			
		Exit Walk Test			

## Disposal and Recycling

Batteries and waste electrical products should not be disposed of with household waste. Please recycle where these facilities exist.



## **Errors and Omissions**

Due to our policy of continuous improvement we reserve the right to change specification without prior notice.

Errors and omissions excepted.

These instructions have been carefully checked prior to publication. However, no responsibility can be accepted by Challenger Security Products for any misinterpretation of these instructions.

# MENU

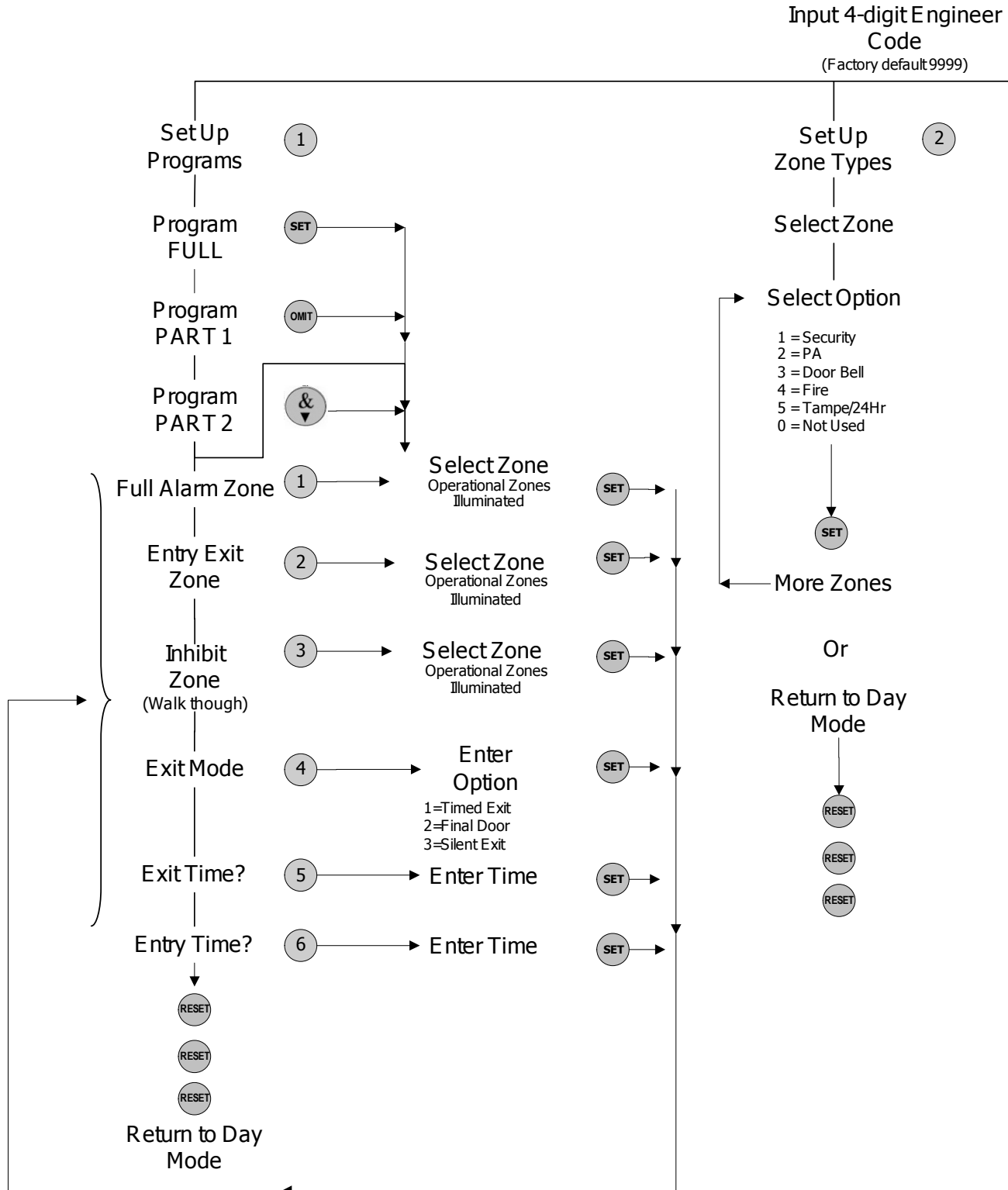

# MAP

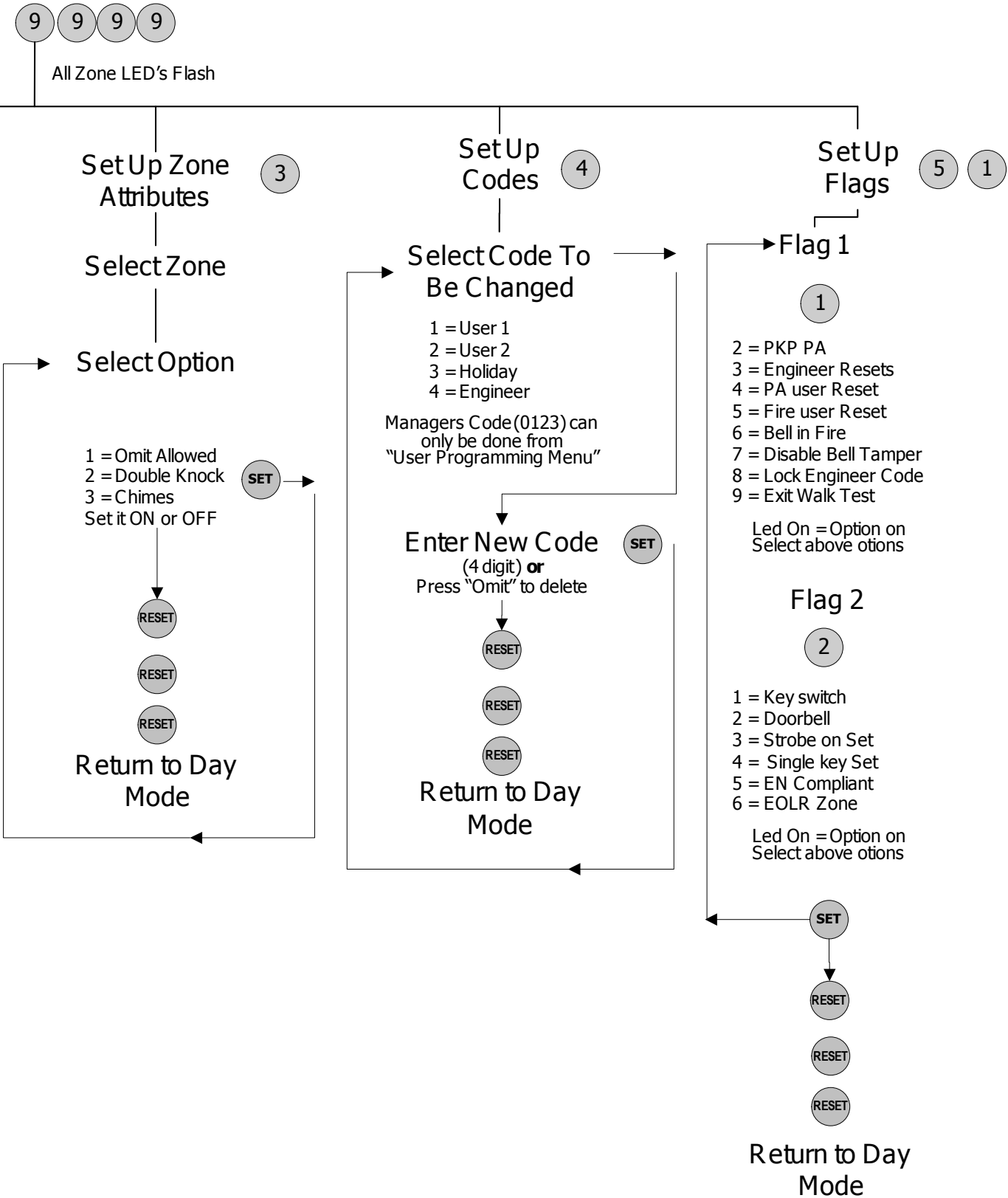

**CHALLENGER SECURITY PRODUCTS**

**10 Sandersons Way**

**Blackpool,**

**FY4 4NB**

**Sales Tel No: 0044 1253 791888**

**Technical No: 0044 1253 792 898**

**Website: [challenger.co.uk](http://challenger.co.uk)**

**Email: [enquiries.challenger@adivision.co.uk](mailto:enquiries.challenger@adivision.co.uk)**